



**Stands +
Lighting Units
for Image Capturing**



The View from the Top

When you think about the positions a camera is used in relation to the subject to be photographed, two possibilities come into mind:

First there is the well-known posture with the camera - sometimes mounted to a tripod - in front of our eye aiming at the subject, either from the front, the side, from below or at an angle from above. The three dimensions of the subject are always preserved, the type of picture only depends from the chosen perspective.

Then there is the vertical view from above where usually the third dimension is lost.

But that is not important for this perspective. In fact this arrangement is for capturing subjects photographically, that are two-dimensional anyway or where surface, structure, pattern or array etc. is the point. This extends to the aerial photograph, that - taken from an absolute vertical position - will serve as a basis for the production of maps.

Back to earth, this camera position is often used for "reproductions". In general a reproduction is understood as a faithful rendition of a copy in a different scale. Even if the reproduction does not stay that "faithful", the copy has to be captured first in its original form. Devices for reproduction or "copying" are well known to all of us.

Photocopiers and flatbed scanners are such devices. Actually everybody who owns a camera has such a "copying machine" provided that the lens will make a sharp picture at the necessary distance.

"If you want to do reproductions with an ordinary camera, the use of a -> stand or a copying device is indispensable." (Urs Tillmanns, Photo Encyclopedia, Schaffhausen 1991).

And here we are, dealing with the subject.



As "faithful rendition" is not always necessary any more, we should perhaps not speak of reproductions, but of a special way of "image capturing", because this has no meaning with respect to the rendition of the "captured" subject. And this fits today's digital photographic world much better. Much of the "capturing work" is done by the flatbed scanner, often limited to letter format sizes, but cameras will also find many fields of application here.

The indispensable stand for that purpose, the often equally essential lighting equipment and many more useful helpers can be found on the following pages. Only when copy stage and storage stage (film, chip or scan area) are absolutely parallel, all angles are exactly the same as the original is and the captured image is in accordance with the original's geometry.

Therefore camera stands for image capturing applications must be stable and precise. They usually have a baseboard to carry the original (sometimes with an integrated lighting system for transparent originals), a column and a camera arm. Various lighting units are available for reflective originals.

The height of the camera arm can be continuously adjusted on the column. In this way the desired frame and reproduction ratio can be set with high precision and consistent parallelism.

Depending on the size and weight of the camera, the size and nature of the original and other requirements there are camera stands in different sizes and lighting units in various configurations. Please read the next pages to get acquainted with the respective product families.



Family Relationships

Combined with a suitable camera, stand and lighting equipment represent a complete problem solution for image capturing tasks. We have organized these camera stands and lighting units in different system families. We use the term "system" because all devices can be adapted to various requirements due to their modular construction and additional upgrade components.



The rePRO system

For professional requirements in conventional and digital image capturing

Grouping the devices in families, links units and components that fit together and function together. Besides that, it helps to find the best choices for the specific requirements of the job.

Especially when choosing the light it is essential, that it is suitable and adequate. It is suitable when dimensions and stability match with the type of camera stand. That is why you will find the suitable lighting units always within the same system family.



The Copylizer system

A universal capturing tool, especially for digital applications.

Many factors have to be considered when checking if the lighting equipment is adequate: size, nature and reflection properties of the photographic subject as well as the type of "film" used in the camera. Especially with conventional chemical film the color temperature of the light should "fit" the film: approximately 5000 Kelvin for daylight film, 3200 - 3400 Kelvin for artificial light film.

When using digital "film", that is in digital photography, new requirements can be important depending on the way, CCD elements are arranged (chip or line). Especially with line scanning cameras and cameras or backs using microscanning or multishot mode, there is a demand for high stability of the light. High-frequency lighting systems are the preferred solution.



The R1 system

High flexibility and extraordinary adaptability are the key features and enable even the accomplishment of very special jobs.



The R2 system

A "amateur system", also suitable for certain professional requirements.



The reprokid

Everything becomes smaller, lighter, more compact.

A Survey to Begin with

In the tables on these pages you will find all essential specifications of stands and lighting units for image capturing. They provide a quick survey and an easy comparison of selected data.

Most notably they comprise some important information for practical application: the maximum covered original width in relation to specific focal lengths of lenses as well as values of illuminance and feasible exposure time settings with the lighting units.

STANDS

Designation	Code no.	Column height (cm/in)	Illumin. area (LF) or baseboard (cm/in)	Original width ¹ (cm/in) for focal length of lens ²		Suitable lighting unit	
				50 mm	100 mm		
Copylizer executive	5232	100/40	LF 43x35/17x14	53/21	27/11	5276/5277/5280/5281 5276/5277/5280/5281 5270	Copylizer
	5212	100/40	LF 43x35/17x14	53/21	27/11		
	5211	100/40	LF 43x35/17x14	53/21	27/11		
Copylizer initial	5206	67/26	LF 20x18/8x7	35/14	17/7	5266 5265	Copylizer
	5205	67/26	LF 20x188/7	35/14	17/7		
RSP rePRO	5612 mit 5615 und 5616/5617	150/60 66/26	80x60/31x24, LF 48x43/19x17	88/35	44/17	5656	rePRO
RSX	5512	120/47	60x50/24x20	66/26	33/13	5589/5590/5588/ 5558/5557/5556/ 5591/5595/5552/ 5554/5563 ³⁾ /5564 ³⁾ / 5568 ³⁾	R1
RS 10	5513	100/40	60x50/24x20	53/21	27/11		
RS 1	5510	100/40	45x50/18x20	53/21	27/11		
RS 1	5511	100/40	45x50/18x20	53/21	27/11		
RS 1 microdrive	5507	100/40	45x50/18x20	53/21	27/11		
RS 2 XA	5411	76/30	40x50/16x20	38/15	19/7	5454/5453/5462/5450 5454/5453/5462	R2
RS 2 CP	5301	60/24	40x42/16x17	29/11	15/6		
reprokid	5360/5361	59/23	32x38/13x15	33/13	16/6	included with 5360	repro- kid

¹⁾ at maximum height

²⁾ focal length is related to 35 mm format (24 x 36 mm)

³⁾ in connection with 5560 holding rods

LIGHTING UNITS

Designation	Code no.	Power (Watt)	Color temp. (Kelvin)	Illuminance (Lux) ⁴⁾	Time/ Aperture ⁵⁾	Suitable stand	Lamp	
RB 4.55 HF	5280, 5281	4 x 55	5400	7500	1/30	5232, 5212	3454	Copyizer
RB 4.36 HF	5276, 5277	4 x 36	5400	4700	1/15	5232, 5212	5567	
RB 2.36	5270	2 x 36	5400	1500	1/8	5211	5567	
RB 2.18 HF	5266	2 x 18	5400	1160	1/4	5206	5458	
RB 2.18	5265	2 x 18	5400	1160	1/4	5205	5458	
RB 5056 HF	5656	4 x 55	5400	7900	1/30	5612 with 5615 and 5616/5617	3454	rePRO
RB 5055 HF	5589/5590	4 x 55	5400	7900	1/30	5512, 5513, 5510, 5511, 5507	3454	R1
RB 5004 HF	5558/5588	4 x 36	5400	4900	1/15		5567	
RB 5004	5557	4 x 36	5400	3100	1/15		5567	
RB 5000 DL	5556	2 x 36	5400	1600	1/8		5567	
RB 5003 UV	5591/5595	6 x 18	UV-A, wave length 366 nm				5569	
RB 300	5552	2 x 300	3200	9000	1/30		3038	
RB 104	5554	4 x 150	3000	9700	1/30		3124 ⁶⁾	
		4 x 150	3200	3900	1/15		3128 ⁶⁾	
		4 x 250	3000	20000	1/60		3130 ⁶⁾	
		4 x 250	3400	13000	1/60		3127 ⁶⁾	
RB 3³⁾	5563	2 x 150	3200	5000	1/15		3128 ⁶⁾	
		2 x 250	3400	15000	1/60		3127 ⁶⁾	
GNT³⁾	5564	2 x 150	3200	5400	1/15		3128 ⁶⁾	
RL 100 Vario³⁾	5568	2 x 250	3400	15200	1/60	3127 ⁶⁾		
		2 x 100	3200	8600	1/30	3054		
RB 218 HF	5454	2 x 18	5400	1160	1/4	5301, 5411	5458	R2
RB 218	5453	2 x 18	5400	1160	1/4	5301, 5411	5458	
RB 260 digital	5462	2 x 11	6000	1650	1/8	5301, 5411	5460	
RB 2	5450	4 x 75	3000	1400	1/8	5411	4356 ⁶⁾	
R 2 CP	5303	4 x 150	3000	3000	1/15	5411	3124 ⁶⁾	
		2 x 11	6000	1650	1/8	included	5460	
reprokid	5360	2 x 150	3200	14000	1/60	included	3128 ⁶⁾	repro- kid
		2 x 250	3400	31000	1/125	included	3127 ⁶⁾	

³⁾ in connection with 5560 holding rods

⁴⁾ measured with highest possible evenness of illumination in consideration of the adjustability on the lamp arms to the subject surface: tabloid format, R2 system and reprokid: letter format

⁵⁾ approx. exposure time in seconds at f=8

⁶⁾ not included. 3127, 3128 are reflector lamps, 3124, 3130, 4356 are lamps without reflector

Professional in Every Respect



When you need a maximum in stability, solidity and load capacity, the rePRO system is the right choice.

This system is not only at home in photo and video studios, but also in technology, forensics and science, education, research and media production. Because of its extremely high level of stability the rePRO system is especially suitable to capture large format

reflective or transparent originals with digital cameras in line scanning, micro scanning or multi shot mode.

The modular-designed stand includes a table with fixed working height and a column that is mounted to the rigid base. The optional lighting units also mount to the table. According to the job, the table can be equipped with a large base plate for reflective originals or with a trans-illuminator for transparent originals.

Height adjustment of camera level is motorized and works individually along the entire column via remote control. The camera platform can travel up and down at two speeds, regardless of the supported load.

For precise positioning of the optical axis of the camera, the camera carrier can be shifted horizontally and, in addition, can be tilted by +/- 90 degrees.

The column, made of a multi-section special extrusion, is mounted to a firmly attached die-cast base and is extremely sturdy and vibration-resistant.

For reflective originals a compatible lighting unit is available.

This professional work station - equipped with a suitable camera system of your choice - offers optimum conditions for sophisticated image capturing tasks.

5612 Column

Made of special aluminum tube, black anodized, with printed cm and inch scales. Height adjustment motorized, with two speeds. Cable remote control. Constant adjustment speed, independent of load. Any height position is exactly held via self-limiting worm-gear. Automatic end switch by photo sensors. Camera platform horizontally adjustable by parallel guides with friction drive, hand cranks for right-hand/left-hand operation, two locking screws. Build-in spirit level. Camera mounting plate 13 x 13 cm (5.1 x 5.1 in.), tiltable by +/- 90°.

Column height: 150 cm (60 in.)
Maximum load: approx. 15 kg (33 lbs.)
Mounting thread: 1/4" / 3/8" exchangeable

5615 Table Frame

With aluminum die-cast base for 5612 column. Demountable steel tube construction. Stacking tray 80 x 50 cm (31 x 20 in.) Height-adjustable feet.

Height without base: approx. 88 x 66 x 78 cm (34.6 x 26 x 30.7 in.), required floor space: 88 x 104 cm (34.6 x 41 in.)

5617 Trans-Illuminator

To be inserted in the 5615 table frame. Illuminated area 48 x 43 cm (18.9 x 16.9 in.), glass cover plate. Total working area 80 x 60 cm 31.5 x 23.6 in.)

Lamps: 4 x 55 W. Built-in fan cooling, no thermal load on originals.

Luminance 6700 cd/m², high-frequency operation. Color temperature of lamps 5400 K, CRI = 90-100, Average service life approx. 8000 hours.

5627 Close-up-Adapter

Bracket to reduce the minimum camera-to-baseboard distance. Mounts on the camera carrier.

4421 rePRO-Adapter

For use of R1 system camera arms.

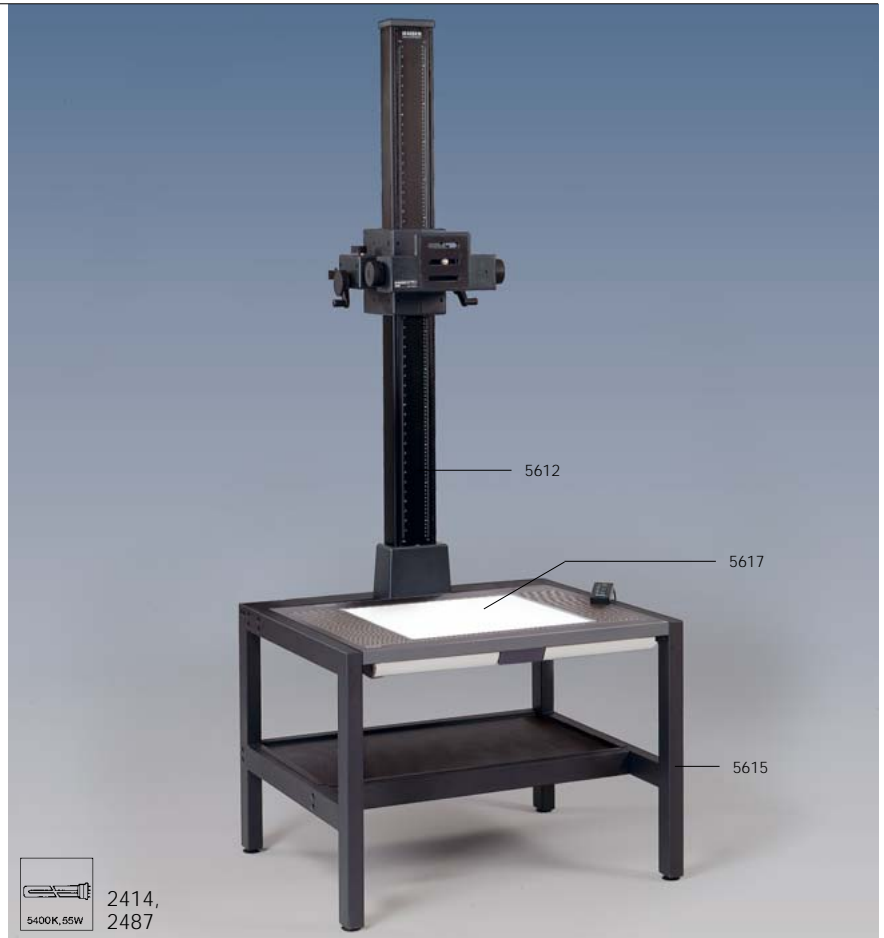

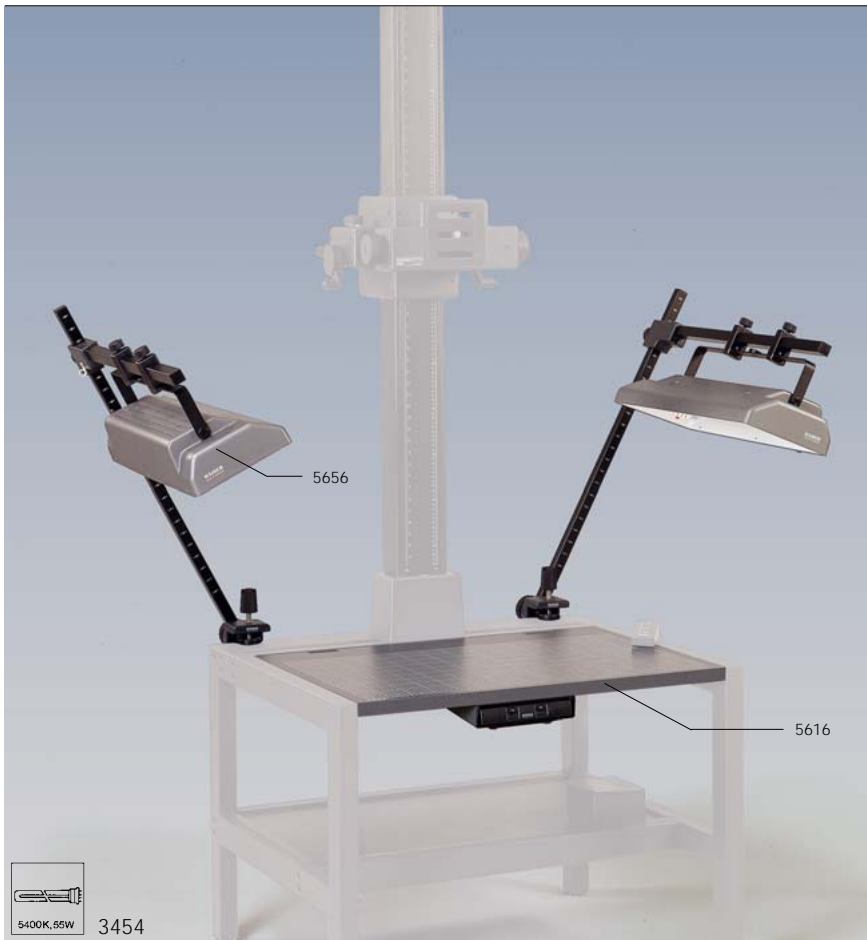

5656 RB 5056 HF Lighting Unit

Two light banks with high-gloss inside reflectors. Light emitting area 64 x 21 cm (25.2 x 8.3 in.) each. Each bank is equipped with two 55 watt daylight fluorescent lamps, color temperature 5400 K, CRI = 90-100. All-electronic high-frequency operating system (approx. 40 kHz) for immediate ignition and flicker-free operation, can be used with line scanner, micro scanning and multishot digital cameras and backs. Lights can be tilted and shifted. Horizontal lamp arms can be adjusted continuously in height. Vertical lamp arms with height markings, tiltable with detents. Mounted with strong die-cast clamp bases, clamp width 15 to 55 mm (0.6 - 2.1 in.). Separate control box. Lamps can be switched individually. Cord: 2.50 m (8 ft.)

5592 Filter Holder

Guide rails for slide-in filters for attachment to 5656. Two pairs.

5593 Diffusion Screens

Fine-structured acrylic glass. Slides in 5592 filter holders. 2 pieces.

5594 Polarizers

Attaches to 5656 with help of 5592 filter holders. 2 pieces.

5616 Base Board

To be inserted in the 5615 Table Frame. Dimensions (WXD): 80 x 60 cm (31.5 x 23.6 in.). High-compressed wooden material, all-side plastic-laminated, with printed grid and cm and inch scales. Includes slide-in carrier for control box of optional lighting unit.

5614 Wall Mount

For 5612 column. Lower part with base, spirit level and compartment for power supply. Top section adjustable for vertical column positioning. Screws and dowels included. Distance wall - column: approx. 35 cm (13.8 in.)
Distance wall - camera platform: approx. 51 - 73 cm (20.1 - 28.7 in.)

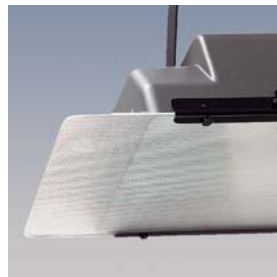

eVisionary: The Copylizer

Everywhere in industry and administration, in medicine, science and research, in the entire area of communication and information technologies, where photos and other originals have to be copied, catalogued, archived, processed or transformed, there is one thing you need apart from the camera system of your own choice: a copylizer. It provides reliable camera mounting and suitable lighting:

- for photographic and electronic capturing of subjects of any kind, including three-dimensional subjects,
- for electronic documentation using digital or analogue camera systems,
- for capturing documents, logos, symbols, photos and drawings for further processing in DTP systems or for further use in video conferences or online networks,
- for reproducing and documenting X-ray films, large format slides, silhouetted subjects and transparent objects,
- for making presentation slides,
- as a video presenter in schools and universities, at training courses and meetings, in advertising, industry, medical imaging and for use by military and public authorities,
- for integration into evaluation systems for quality testing and monitoring in industry labs.

The stands can be used either with or without the respective side lighting units, as there are mounting provisions on all stands.





2136,
2477

5211/12/32 Copylizer eVision exe.cutive/ eVision exe.cutive HF

Camera stand with integrated transmitted light source. Illumina base with four 13 W daylight fluorescents 5400 K, illuminated area 43 x 35 cm (16.9 x 13.8 in.). Illuminance 3300 cd/m². Mounting fixtures for optional side lighting unit. Height-adjustable feet. Base with spirit level. 70 mm (2.8 in) wide high-stability, vibration-resistant column made of special aluminum tubing, matt black anodized, with cm and inch scales. Hand-crank operated height adjustment of camera arm by friction drive on plastic bearings. Weight compensation by integrated coil spring, RTP camera arm with horizontally adjustable camera platform, camera body positioning device and interchangeable 1/4" and 3/8" threads.

Illumina base (WxD): 63 x 55 cm
(24.8 x 21.7 in.)

Column height: 1 m (40 in.)

Max. load: approx. 4 kg (8.8 lbs.)

Mains cord: 2,5 m (6.5 ft.)

5211: Mains frequency operation
Not available in 120 volt

5212: Illumina base with high-frequency operation system (approx. 40 kHz) for flicker-free operation, especially important for use with digital scanning cameras.

5232: Illumina base with high-frequency operation system, dimmable.

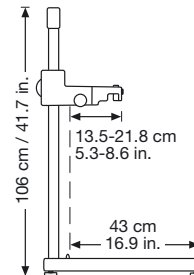

5276/77/80/81
RB 4.36 HF/RB 4.55 HF Copylizer
Lighting Unit

Lighting unit consisting of two light banks and lamp arms. Lamps can be tilted, shifted and adjusted in height. Vertical arms with height markings, tiltable with detents. Connects to and is operated via copylizer illumina base. Lights with high-gloss inside reflectors for high light output plus filter holder and diffusion screen. High-frequency operating system (approx. 40 kHz) for universal use with digital applications.

5276: Lamps: 2 x 36 w each, daylight fluorescent lamp 5400 K, CRI = 90-100, light emitting area approx. 50 x 21 cm (19.7 x 8.3 in.)

5277: same as 5276, but with dimmable lights

5280: Lamps: 2 x 55 w each, daylight fluorescent lamp 5400 K, CRI = 90-100, light emitting area approx. 64 x 21 cm (25.2 x 8.3 in.)

5281: same as 5280, but with dimmable lights

5270
RB 2.36 Copylizer Lighting Unit

Lighting unit consisting of two light banks and lamp arms. Lamps can be tilted and adjusted in height, with filter holders and diffusion screens. Vertical arms with height markings, tiltable with detents. Connects to and is operated via copylizer illumina base.

Lamps: 1 x 36 w each, daylight fluorescent lamp 5400 K, CRI = 90-100, light emitting area approx. 50 x 21 cm (19.7 x 8.3 in.)

5256
Clamp Base

For attaching lighting units 5265/5266/5270/ 5276/5277/5280/ 5281 to regular boards up to 48 mm (1.9 in.) thickness. 2 pieces.



for 5270,
5276-77:



5567

for 5280/81:



3454



5270



5256



5241/42/62 Illumina Base

Can be combined with components of the R1 system. Trans-illuminator with four 13 w daylight fluorescent lamps 5400 K, illuminated area approx. 43 x 35 cm (16.9 x 13.8 in.), illuminance approx. 3300 cd/m². Optional side lighting units can be attached, connected and operated. Height-adjustable feet. Base with spirit level for 70 mm (2.8") wide column.

Outside dimensions (WxD):
approx. 63 x 55 cm (24.8 x 21.6 in.)
Mains cord: approx. 2.5 m (6.5 ft.)

5241: Mains frequency operation.
Not available in 120 volts

5242: High-frequency operation (approx. 40 kHz) for universal use with all digital applications.

5262: same as 5242, lights dimmable.

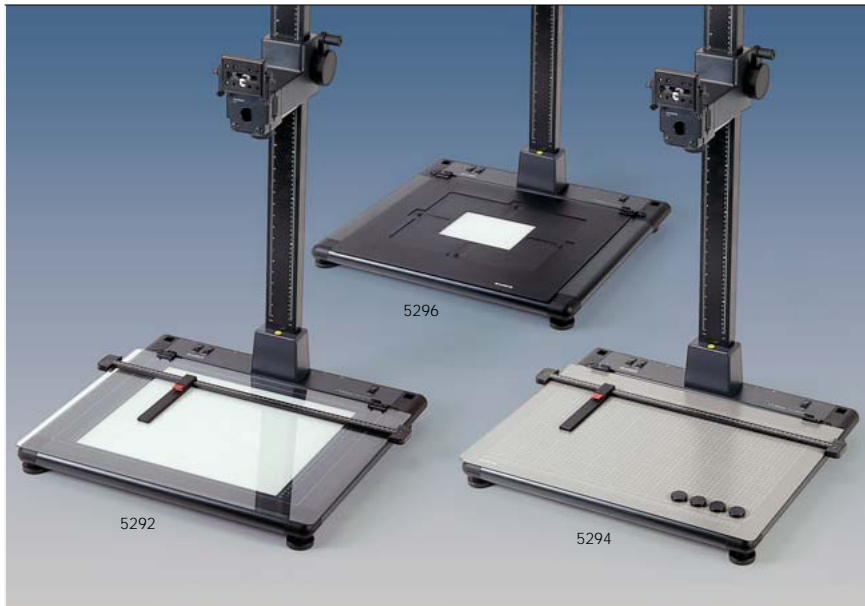

Accessories for 5211/12/32 Copyizers and 5241/42/62 Illumina Bases

5292 Pressure Plate. Made of high-quality crystal glass to press „wavy“ originals. Can be fitted to the hinge of the illumina base and is easily lifted. With adjustable stop guides.

5294 Metal Plate. For holding originals with magnetic holders (four included) and as a protective cover of the acrylic glass plate. Can be fitted to the hinge of the illumina base and is easily lifted. With printed grid for positioning and adjustable stop guides.

5296 Masking Frame. With adjustable masks to prevent influence of stray light when capturing smaller transparent originals between 24 x 36 mm (35 mm slide) and 13 x 18 cm (5 x 7"). Can be fitted to the hinge of the illumina base and is easily lifted.

5205-06
**Copylizer eVision ini.tial/
eVision ini.tial HF**

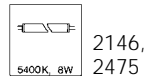
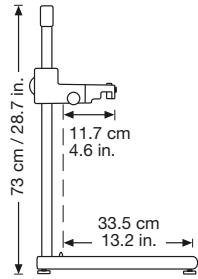

5265-66
**RB 2.18 / RB 2.18 HF Copylizer
Lighting Unit**

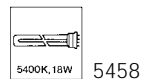

Camera stand with integrated trans-illuminator. Illumina base with four 8 W daylight fluorescents 5400 K, illuminated area 20 x 18 cm (7.9 x 7.1 in.). Illuminance 4600 cd/m². Mounting fixtures for optional side lighting unit. Height-adjustable feet. 70 mm (2.8 in) wide high-stability, vibration-resistant column made of special aluminum tubing, matt black anodized, with cm and inch scales. Hand-crank operated height adjustment of camera arm by rack-and-pinion drive and additional fine drive. Weight compensation by integrated coil spring, RA 101 camera arm with camera body positioning device and interchangeable 1/4" and 3/8" threads. Illumina base (WxD): 32 x 45 cm

(12.6 x 17.7 in.)
Column height: 67 cm (26 in.)
Max. load: approx. 4 kg (8.8 lbs.)
Mains cord: 2,5 m (6.5 ft.)

5211: Mains frequency operation.
Not available in 120 volt
5212: Illumina base with high-frequency operation system (approx. 40 kHz) for flicker-free operation, especially important for use with digital scanning cameras.



Lighting unit consisting of two lights and holding arms. Lamps can be tilted and adjusted in height, vertical arms tiltable with detents.

Lamps: 1 x 18 w each, daylight fluorescent lamp 5400 K. Separate control box.

5265: Mains frequency operation
5266: High-frequency operation (approx. 40 kHz)



5298
Metal Plate

For 5205 and 5206 Copylizer. For holding originals with magnetic holders (four included) and as a protective cover of the acrylic glass plate. Can be fitted to the hinge of the illumina base and is easily lifted.



The Power of Possibilities



The R1 system is a powerful system. It is universal, sophisticated, flexible, versatile, multi-functional and adaptable.

It is designed for professional users and dedicated photographers and offers high stability, angular precision and quality workmanship.

It is ideal for use with conventional and digital camera systems up to 4 kg (8.8 lbs.) total weight and offers a vast range of components and accessories.

Base boards of various sizes, columns of different height, camera arms with a variety of adjustment options, lighting units with various lamps and reflectors, working at different power levels, with various mounting and adjustment options make it possible to adapt the units to individual requirements.

This system is completely modularized and therefore allows also customized configurations.

5512 RSX Camera Stand

Big non-reflecting matt grey baseplate with printed grid, cm and inch scale. Feet adjustable in height. Spirit level in column base. Especially wide and low-vibration column made of matt black anodized aluminium tubing with cm and inch scale. Height adjustment with hand crank and rack with extra weight compensation by integrated coil spring. Blocking screw to stop accidental changing of height. RTX camera arm with adjustable and pivotable camera holder. Camera can be mounted forwards or backwards. Camera platform can be horizontally adjusted by fine mechanism. Interchangeable $1/4''/3/8''$ mounting thread. Including dust hood.

Baseplate: approx. 600 x 500 x 32 mm
(23.6 x 19.7 x 1.3 in.)

Height of column: 1.20 m (4 ft.)

Loading capacity: 3.5 kg (7.7 lbs.) max.

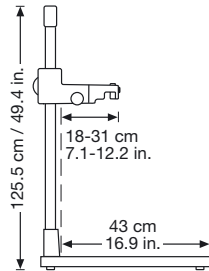



5513 RS 10 Camera Stand

Large non-reflecting, matt grey baseboard with a printed fine grid and cm/inch scale. Height-adjustable feet. Spirit level integrated into the base. Especially wide, virtually vibration-free column made of matt black anodised aluminium section tube with cm/inch scale. Hand-cranked, rack-and-pinion height adjustment, additionally counter-balanced by a built-in scroll spring. Locking screw prevents inadvertent changing of the adjusted height. RTP camera arm (5524) with precision, parallel-guided horizontal adjustment over approx. 8 cm (3.1 in.). Reversible mounting thread $\frac{1}{4}$ " / $\frac{3}{8}$ ". Including dust cover.

Baseboard (WxHxD): approx. 600 x 32 x 500 mm (23.6 x 1.3 x 19.7 in.)
 Column height: approx. 1 m (39 in.)
 Maximum load: 4 kg (8.8 lbs.)

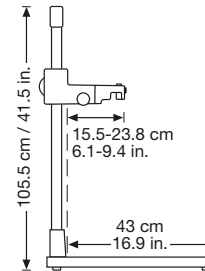

5508 Base Stand

For converting RS1 system camera stands from table to free-standing model. Also suitable for all baseboards from 45 x 50 cm to 60 x 80 cm (17.7 x 19.7 in. to 23.6 x 31.5 in.). Height-adjustable feet. Slide-in compartment for control box of optional lighting unit. Dimensions (WxHxD): approx. 580 x 510 x 595 mm (22.8 x 20.1 x 23.4 in.)

5510-11 RS 1 Camera Stand

Non-reflecting matt gray base board with printed fine grid. Feet adjustable in height. Spirit level in column base. Extra-wide and extremely vibration-resistant column of dull black anodized aluminium tubing with cm and inch scales. Hand crank-operated height adjustment by friction drive on plastic bearings. Weight compensation by roll-off spring mechanism.

Base board: approx. 450 x 500 x 28 mm
(17.7 x 19.7 x 1.1 in.)

Column height: approx. 1000 mm (39.4 in.)

5511 RS 1 Camera Stand

With RT 1 copy and tilting arm with two camera fastening points. Interchangeable threaded bush $1/4"/3/8"$. Camera carrier pivots and slides horizontally. Maximum load: 3 kg (6.6 lbs.)

5510 RS1 Camera Stand

With RA 1 camera arm with interchangeable threaded bush $1/4"/3/8"$ and camera adjustment device.

Maximum load: 4 kg (8.8 lbs.)

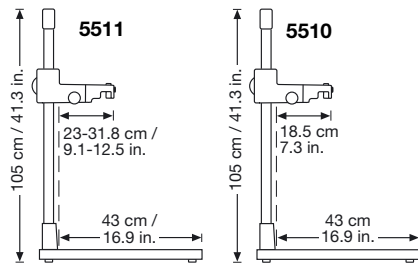

5507 RS 1 „microdrive“ Camera Stand

Same as RS1 Camera Stand (5510), but with hand-cranked, rack-and-pinion height adjustment, additionally counter-balanced by a built-in scroll spring. Additional fine drive with 1:10 step-down transmission for super-fine adjustment. Locking screw prevents inadvertent changing of the adjusted height.

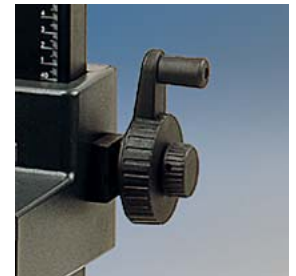



5589-90 **RB 5055 HF Lighting Unit**

Cold-light unit with two light banks, each one fitted with two daylight fluorescent lamps, high-gloss inside reflectors and high-frequency operating system. Lights can be tilted and shifted. Horizontal lamp arms can be adjusted continuously in height. Vertical lamp arms with height markings, tiltable with detents. Mounted with strong die-cast clamp bases, clamp width up to 48 mm (1.9 in.) Separate control box.

Lamps: 4 x 55 watt
 Color temperature: 5400 K
 Color rendition index: CRI = 90-100 (1A)
 Light emitting area: 64 x 21 cm
 (25.2 x 8.3 in.)

5589: continuously dimmable down to 10%
5590: not dimmable



5591/95 **RB 5003 UV / RB 5003 UV-HF** **Lighting Unit**

UV lighting unit with two light banks, each one fitted with three UV-A fluorescent lamps for applications in UV and fluorescence photography. Lights can be tilted and shifted. Horizontal lamp arms can be adjusted continuously in height. Vertical lamp arms with height markings, tiltable with detents. Mounted with strong die-cast clamp bases, clamp width up to 48 mm (1.9 in.) Separate control box.

Lamps: 6 x 18 watt UV-A
 Wave length: 366 nm
 Light emitting area: 64 x 21 cm
 (25.2 x 8.3 in.)

5591: Mains frequency operation
5595: High-frequency operation
 (approx. 40 kHz)

5569 **UV-A Fluorescent Lamp**

18 watt, average service life 8000 hours,
 G 13 socket, length 590 mm. 1 piece.

5557-58/5588
RB 5004/RB 5004 HF Lighting Unit

Cold-light unit with two light banks, each one fitted with two daylight fluorescent lamps. Lights can be tilted and shifted. Horizontal lamp arms can be adjusted continuously in height. Vertical lamp arms with height markings, tiltable with detents. Mounted with strong die-cast clamp bases, clamp width up to 48 mm (1.9 in.). Separate control box.

Lamps: 4 x 36 watt
Color temperature: 5400 K
Color rendition index: CRI = 90-100 (1A)
Light emitting area: 50 x 21 cm
(19.7 x 8.3 in.)

5557: Mains frequency operation

5558: High-gloss inside reflectors and high-frequency operating system (40 kHz)

5588: High-gloss inside reflectors and high-frequency operating system (40 kHz), continuously dimmable down to 10%.



5556
RB 5000 DL Lighting Unit

Cold-light unit with two light banks, each one fitted with one daylight fluorescent lamp. Lights can be tilted. Horizontal lamp arms can be adjusted continuously in height. Vertical lamp arms with height markings, tiltable with detents. Mounted with strong die-cast clamp bases, clamp width up to 48 mm (1.9 in.).

Lamps: 2 x 36 watt
Color temperature: 5400 K
Color rendition index: CRI = 90-100 (1A)
Light emitting area: 50 x 21 cm
(19.7 x 8.3 in.)

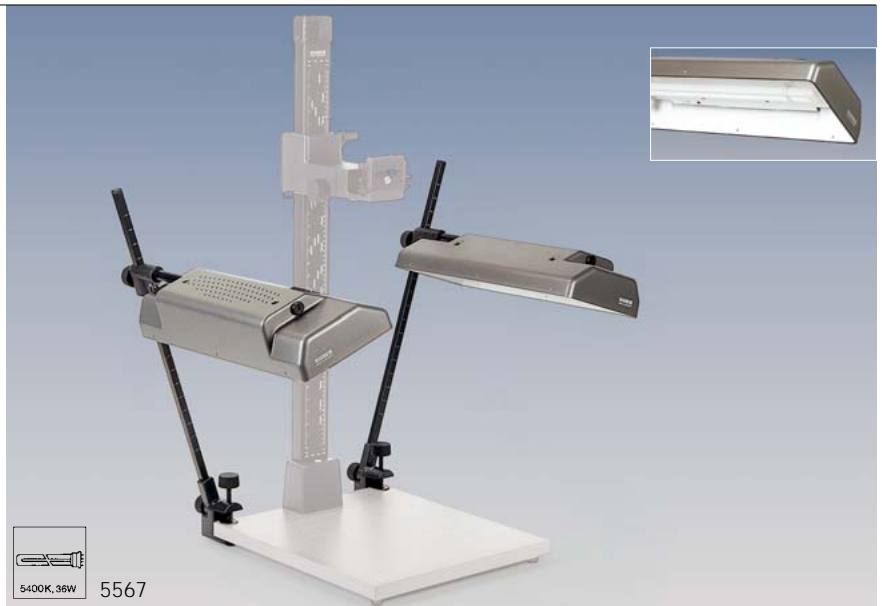

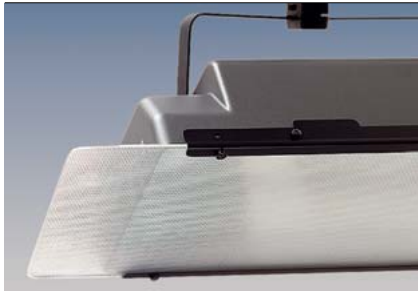

5582/92 Filter Holders

Guiding rails to attach slide-in filters to camera stand lighting units. 2 pairs.

5582: For reflector size 50 x 21 cm (19.7 x 8.3 in.) (5556-58/5588)

5592: For reflector size 64 x 21 cm (25.2 x 8.3 in.) (5589-91/5595)

5583/93 Diffusion Screens

Fine-structured acrylic glass. Mounts to camera stand lighting units in connection with 5582/92 Filter Holders. 2 pieces.

5583: For reflector size 50 x 21 cm (19.7 x 8.3 in.) (5556-58/5588)

5593: For reflector size 64 x 21 cm (25.2 x 8.3 in.) (5589-91/5595)

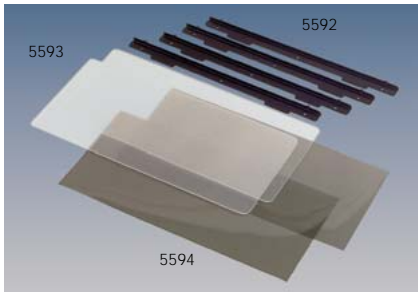

5594 Polarizers

Mounts to lighting units 5556-58, 5588-91, 5595 in connection with 5582/92 Filter Holders. 2 pieces.

Dimensions: 64 x 21 cm (25.2 x 8.3 in.), can be trimmed to 50 x 21 cm (19.7 x 8.3 in.)

Fluorescent Lamps

Replacement lamps for rePRO, Copylizer and R1 system. Daylight fluorescent tubes. Color temperature 5400 K, light color 12, color rendition index CRI=90-100. Average service life: approx. 8000 hours with constant color temperature. For critical requirements on color-correct reproduction replace fluorescents replace in sets.

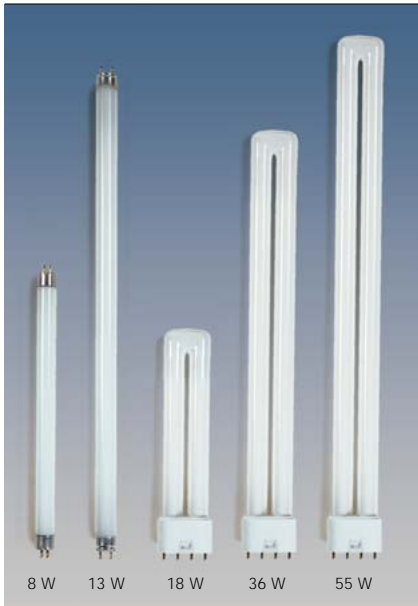

	Code	Power	Socket	Length (w/o pins) mm/in	Tube-ø (mm)	Qty. (pieces)	fits
Tube shape	2146	8 W	G 5	288 mm	16	1	5205-06
	2475	8 W	G 5	288 mm	16	4	5205-06
	2136	13 W	G 5	517 mm	16	1	5211/12/32/41/42/62
	2477	13 W	G 5	517 mm	16	4	5211/12/32/41/42/62
Dulux	5458	18 W	2 G 11	217 mm	2 x 17,5	1	5265-66
	5567	36 W	2 G 11	411 mm	2 x 17,5	1	5270, 5276-77, 5556-58, 5588
	2414	55 W	2 G 11	533 mm	2 x 17,5	1	5617
	2487	55 W	2 G 11	533 mm	2 x 17,5	4	5617
	3454	55 W	2 G 11	533 mm	2 x 17,5	1	5280-81, 5589-90, 5656

5552
RB 300 Lighting Unit

With two convection-cooled halogen lights. Lights can be tilted and shifted. Horizontal lamp arms can be adjusted continuously in height. Vertical lamp arms with height markings, tiltable with detents. Mounted with strong die-cast clamp bases, clamp width up to 48 mm (1.9 in.). Lights can be switched separately. Lamps included.

Lamps: 2 x 300 Watt
Color temperature: 3200 Kelvin
Cord: 2 x 4 m (2 x 13.1 in.)

3038/3058
Halogen Lamp

For RB 300 Lighting Unit. 300 W.

3038: 3200 K, 7300 lm, average service life approx. 75 hours, 1 piece.

3058: 3400 K, 8500 lm, average service life approx. 15 hours, 1 piece.



5554
RB 104 Lighting Unit

With four reflector lights with E 27 screw-in socket, suitable for photofloods up to 250 watt. Lights can be switched separately. Lights can be tilted and shifted. Horizontal lamp arms can be adjusted continuously in height. Vertical lamp arms with height markings, tiltable with detents. Mounted with strong die-cast clamp bases, clamp width up to 48 mm (1.9 in.) Reflector-diameter: approx. 14 cm (5.5 in.). Cord: 2 x 2 m (2 x 6.5 in.). Supplied without lamps.

Recommended lamps:

3124: Opal lamp 150 W, 3000 K

3130: Photoflood 250 W, 3000 K
(without reflector)

3128: Reflector lamp: 150 W, 3200 K

3127: Reflector lamp: 250 W, 3400 K





**5560
Lamp Arms**

Complete set for two or four lights. The arms are adjustable in height and angle and can be fitted with 5563 and 5564 Light Fixtures, with RL 100 Vario Lights (5568) and with Flash/Light Fixtures 5571 and 5574. Clamp attachment on boards up to 48 mm (1.9 in.).

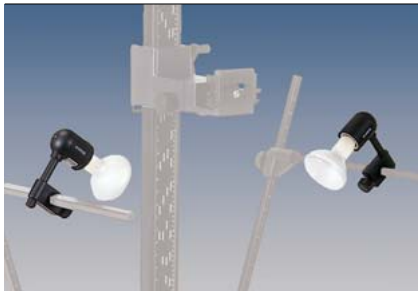

**5563
RB 3 Lamp Fixtures**

For use with 5560 Lamp Arms.

Lamps: 2 x 250 W max., E 27

Cord: 2 x 2 m (6.5 ft.) with cord switch
2 pieces, without lamps.



3127/28



**5571
Flash/Light Fixtures**

For fastening conventional flashes or lights with accessory foot or 1/4" mounting thread to holding rods with 16 mm (.63 in.) square tube, e.g. the 5560 Lamp Arms.

5568
RL 100 Vario Lights



3054

For use with the 5560 Lamp Arms and all other camera stand lighting units with holding rods with and edge length of 16 mm (.63 in.).

Two focussable 100 watt halogen lights, separately dimmable down to approx. 20 watt, with gooseneck holders. Operated with two transformers with integrated dimmer.

Specifications:

Halogen lamps: 2 x 12 V, 100 W, 3200 K

Cords: 2 x 4 m (13 ft.)

Not available in 120 V.



93324
Conversion Filter

Safety front attachment with conversion filter and barn doors. For RL 100 Vario Lights. Converts 3200 K to 5400 K.

5564
GNT Lamp Fittings



3127/28

For use with the 5560 Lamp Arms and with other camera stand lighting equipment with holding rods with and edge length of 16 mm (.63 in.). Two lamp fittings for photo lamps with E 27 screw-in thread on gooseneck lamp rods. Without lamps.

Lamps: 2 x 250 Watt max.

Cords: 2 x 2 m (6.5 ft.) with cord switch



5574
GNT Flash/Light Fixtures

For fastening conventional flash units or lights with accessory foot to the 5560 Lamp Arms or to other holding rods with 16 mm (.63 in.) edge length. With gooseneck holders.



Choice and Realization

Within the realm of possibilities inherent in the R1 system, choice and realization must not be too far apart.

The high degree of modularization, the vast range of components and the uncomplicated design of the „interfaces“ provide for so many variations and versions, that there is hardly a requirement that can not be met.

Larger base boards, metal magnetized surfaces, longer or shorter columns, camera arms with various positioning and adjustment possibilities - all this combined with the many options in lighting equipment will lead to a big choice in practical solutions, which can even be adopted later on to modified requirements.

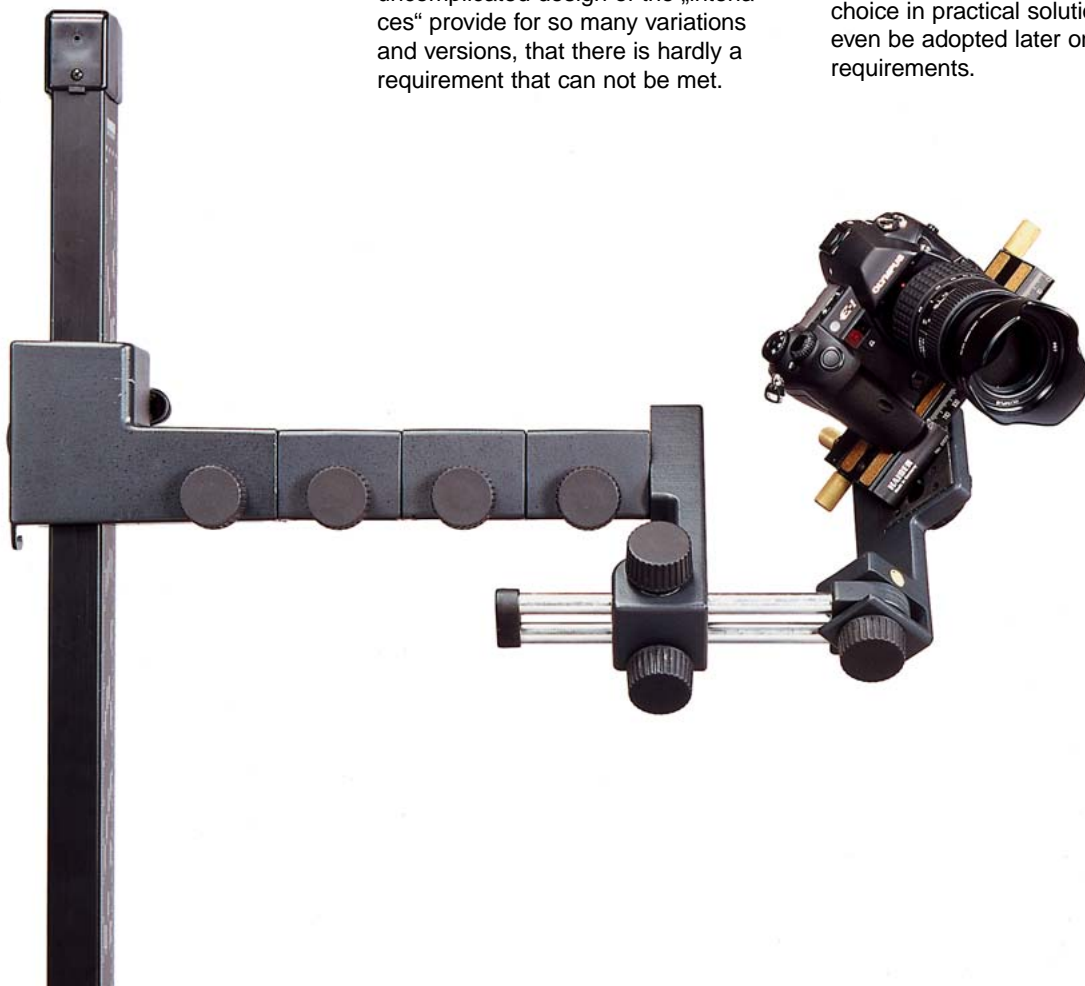

5517-19 Base Board

Matt grey laminated base board with mounted base for attaching column. Printed fine grid with cm and inch scale. Spirit level in base. Individually height-adjustable feet.

Dimensions (WxDxH):

5517: approx. 450 x 500 x 28 mm
(17.7 x 19.7 x 1.1 in.)

5518: approx. 600 x 500 x 32 mm
(23.6 x 19.7 x 1.3 in.)

5519: approx. 800 x 600 x 32 mm
(31.5 x 23.6 x 1.3 in.)

(Dimensions excluding base and feet)

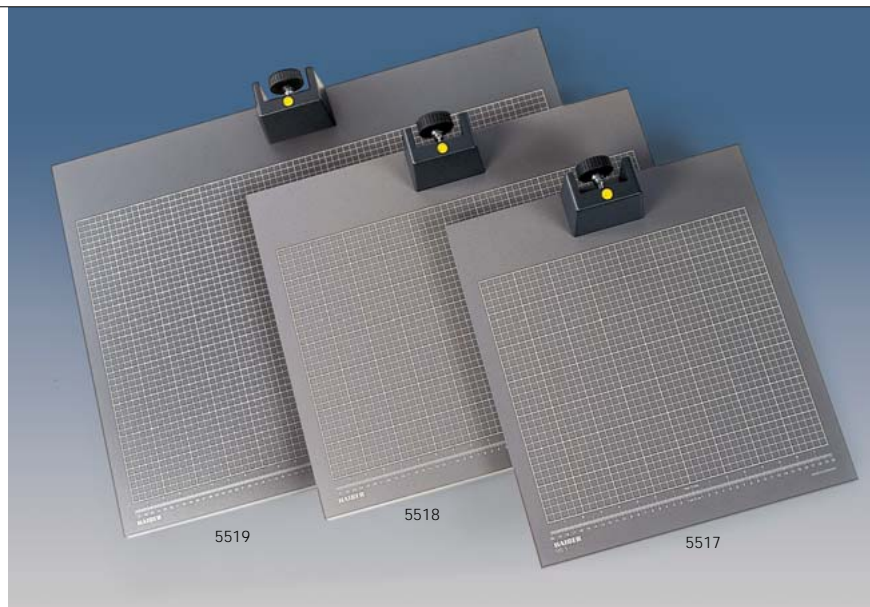

5541-42 Metal Baseplate

Metal base plate for base boards of camera stands and enlargers. Surface with 18 % reflecting matt grey finish for easy determination of exposure for copy work. Marked with grid lines with 1 cm (.4 in.) line intervals and cm and inch scales.

Material thickness: 1.25 mm. Non-slip underside. Including four round magnetic original holders with 32 mm (1.3 in.) diameter for fastening originals or photo paper during enlarging.

5541: Size of marked grid area: 40 x 35 cm (15.7 x 13.8 in.) Dimensions (WxHxD): approx. 454 x 15 x 430 mm (17.9 x .6 x 16.9 in.). Fits on all 45 x 50 cm (17.7 x 19.7) base boards.

5542: Size of marked grid area: 55 x 35 cm (21.7 x 13.8 in.) Dimensions (WxHxD): approx. 604 x 15 x 430 mm (23.8 x .6 x 16.9 in.). Fits on all 60 x 50 cm (23.6 x 19.7 in.) base boards.





4473-76/4408-09 Column

Wide and extremely vibration-resistant column of aluminium tubing with dull black anodized surface and cm and inch scales. With mount and fastening mechanism for camera arms. Height adjustment by hand crank.

Cross-sectional dimensions of the column:
70 x 35 mm (2.8 x 1.4 in.)

4473: Height adjusted by friction gear with plastic bearings, without weight compensation, height 1 m (40 in.)

4474: Height adjusted by friction gear with plastic bearings, weight compensated by built-in roller spring, height 1 m (40 in.)

4475: Height adjusted by gear rack with weight compensation by built-in roller spring, additional 1:10 fine drive. Locking screw for fixing height adjustment. Height 1 m (40 in.)

4476: same as 4475, but without fine drive.

4408: Height adjusted by gear rack, weight compensated by built-in roller spring, locking screw for fixing height adjustment. Height 1.2 m (47 in.)

4409: Height adjusted by friction gear with plastic bearings, weight compensated by built-in roller spring, locking screw for fixing height adjustment. Height: 1.5 m (60 in.)



4412 Wall Mount

Sturdy wall mount for all R1 system columns. Wall mounting with 6 screws. Upper part adjustable for absolutely vertical position. Lower part with base and spirit level. Entire height with 1 m column: 1.16 m (3 ft. 10 in.).

Distance wall - front edge of mount (without camera arm): approx. 25 cm (9.8 in.)

Supplied with screws and dowels.

5528
Object Carrier

To take small objects or flat originals lit from back and/or top. Consisting of 368 x 475 mm (14.5 x 18.7 in.) glass sheet in pivoting frame. Complete object carrier pivotable and adjustable in height. Glass sheet replaceable with translucent acrylic glass (included). Suitable for all 70 mm (2.8 in.) wide columns with separate mount (included).

External dimensions of frame (WxHxD):
approx. 555 x 30 x 425 mm (21.9 x 1.2 x 16.7 in.)

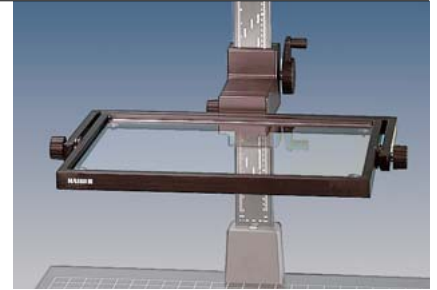

4455
Extension Arm

To extend the camera arm mount. Required for capturing large originals. This increases the distance between the optical axis of the camera lens and the column base by 80 mm (3.2 in.), if the extension arm is attached between the mount and the camera arm.

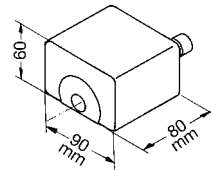



**5522
RTX Camera Arm**

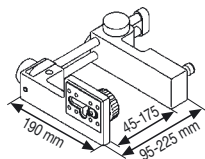

Camera mount with spirit level for fine adjustment. Turns $\pm 180^\circ$ and can be fixed in every position. Camera can be mounted on front or rear. Camera mount horizontally adjustable with fine adjustment.

Interchangeable $1/4'' / 3/8''$. mounting thread.



**5521
RT 1 Copy And Titrng Arm**

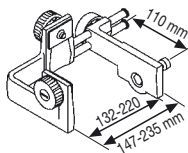

Camera fastening points for horizontal and upright formats, with interchangeable threaded bush $1/4'' / 3/8''$. and rubber rests.

A parallel guide makes the camera platform longitudinally adjustable, and it can be locked in any position. The entire copy and titling arm is tiltable to allow for reproduction of vertical subjects.



**5524
RTP Camera Arm**

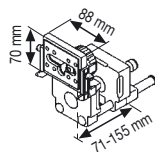

Horizontally adjustable via parallel guides to change the distance to the column. Moves approx. 8 cm (3.1 in.) back and forth. Camera positioning device, adjustable to different camera bodies.

Reversible mounting thread $1/4'' / 3/8''$.



**5520
RA 1 Camera Arm**

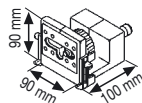

Device for adjusting the camera, can be set to different camera bodies.

Interchangeable $1/4'' / 3/8''$ mounting thread.

5523
RA 101 Camera Arm

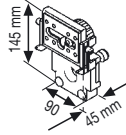

Specially suitable for cameras with large distance between tripod hole and optical axis of lens. Device for adjusting the camera, settable to different camera bodies. Interchangeable 1/4" / 3/8" mounting thread.



5539
RLR Camera Arm

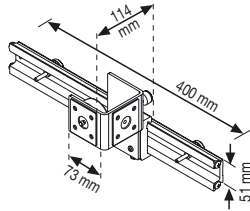

Camera platform can be shifted horizontally to left or right and can be blocked in any position. Adjustable stops for end position of camera. Camera can be mounted for horizontal or vertical format. Especially suitable for use with 5904 Book Holder when copying books page by page. Camera platform moves approx. 15 cm (6 in.) from center to each side.



5540
2CC Camera Arm

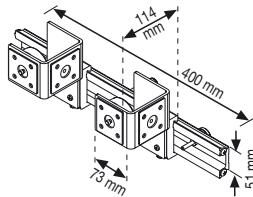

Similar to 5539, but with two camera carriers which can be adjusted separately. For mounting two cameras, e.g. for comparison shots.



5531
Focusing Stage

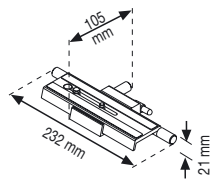

Extremely flat focusing stage with fine drive with spindle. Rapid adjustment with single lever lock. Locking screw. Setting range 120 mm (4.7 in.) with mm scale. Large camera platform with non-slip surface and interchangeable 1/4" / 3/8" mounting thread. 1/4" / 3/8" tripod thread. Made of black anodized aluminum.

Two focusing stages can be combined for crossed stanges.



Lightweight Class



With digital photography cameras become smaller and lighter. Even if the loads are less - the requirements on stability have not changed.

Camera stands and lighting units of the R2 family are „light“ versions of the R1 system. Designed for light-weight cameras, their dimensions and stability are related to the respective needs.

The stands are not only for the majority of digital cameras, compacts and smaller SLRs, but are also suitable for industrial CCD and CMOS cameras.

There is also a range of suitable lighting units: from high-frequency fluorescents to basic tungsten lamp lighting.

5411 RS 2 XA Camera Stand

Non-reflective matt grey baseboard with printed fine grid and cm/inch scale. Matt-black anodised aluminum section tube column with cm/inch scale. Hand-cranked height adjustment by friction drive in plastic bearings. With horizontally adjustable camera arm to change the distance to the column, moves approx. 7 cm (2.7 in.) back and forth. 1/4" mounting thread.

Baseboard (WxHxD): approx. 400 x 25 x 500 mm (15.7 x 1 x 19.7 in.)

Column height: approx. 76 cm (30 in.)

Maximum load: 1.5 kg (3.3 lbs)

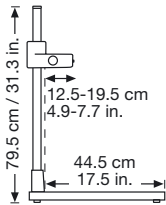

5450 RB 2 Lighting Unit

With four tiltable and adjustable reflectors on mounting arms which are in turn tiltable and adjustable in height. Lights can be switched on separately.

Suitable lamps: 4 x 150 w max.

Clamp attachment for thickness up to 48 mm (1.8 in.).

Cords: 2 x 1.7 m (5 1/2 ft.)

Supplied without lamps.

3124/4356 Opal Lamp

For RB 2 Lighting Unit.

4356: 75 W, 3000 K, E 27, 1100 lm.

Average service life: 100 hrs.

1 piece.

3124: 150 W, 3000 K, E 27, 2500 lm.

Average service life: 100 hrs.

1 piece.





5453-54
RB 218 / RB 218 HF
Lighting Unit

Cold light lighting unit with two small light banks with one daylight fluorescent each. Lights are tiltable and adjustable in height. Angle of vertical arms adjustable by lock joint. Mounted with strong die-cast clamp bases. Clamping width up to 48 mm (1.9 in.) Separate control box.

Lamps: 2 x 18 watt
Color temperature: 5400 K
CRI = 90-100 (1A)

5453: Mains frequency operation
5454: High frequency operation
(approx. 40 kHz)

5458
Replacement Lamp for RB 218

18 W, 5400 K, Light color 12, CRI = 90-100 (1A), average service life 8000 hrs., socket 2 G 11, length 217 mm (8.5 in.). 1 piece.



5462
RB 260 digital Lighting Unit

Cold light lighting unit with two small light banks with one daylight fluorescent each. Lights are tiltable and adjustable in height. Angle of vertical arms adjustable by lock joint. Mounted with strong die-cast clamp bases. Clamping width up to 48 mm (1.9 in.) Lamps can be switched on individually.

Lamps: 2 x 11 W, color temperatur 6000 K, color rendering group 1B. Suitable for use with digital cameras and camcorders.

Not available in 120 V.

5460
Replacement Lamp for
RB 260 digital

11 W, 6000 K, light color 11, color rendering group 1B, average service life 8000 hrs. Socket G 23, length 214 mm (8.4 in.). 1 piece.

5303 R 2 CP Image Capturing Set

Portable camera stand with RB 260 digital Lighting Unit (5462).

Non-reflective matt grey baseboard with printed fine grid and cm/inch scale. Matt-black anodised aluminum section tube column with cm/inch scale. Hand-cranked height adjustment by friction drive in plastic bearings. With horizontally adjustable camera arm to change the distance to the column, moves approx. 7 cm (2.7 in.) back and forth. 1/4" mounting thread. Column folds down on baseboard.

Baseboard (WxHxD): approx. 400 x 25 x 500 mm (15.7 x 1 x 19.7 in.)

Column height: approx. 76 cm (30 in.)
Maximum load: 1.5 kg (3.3 lbs)

RB 260 digital Lighting Unit with two small light banks, tiltable and adjustable in height. Angle of vertical arms adjustable by lock joint. Mounted with strong die-cast clamp bases. Lamps: 2 x 11 W, 6000 K, color rendering group 1B. Suitable for use with digital cameras and camcorders.

Comes in strong carrying case 62 x 58 x 21 cm (24.4 x 22.8 x 8.3 in.) with handle and shoulder strap.

Not available in 120 V.

5301 RS 2 CP Camera Stand

same as 5303, but without lighting unit.

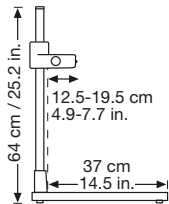

The Story of „Repro the Kid“

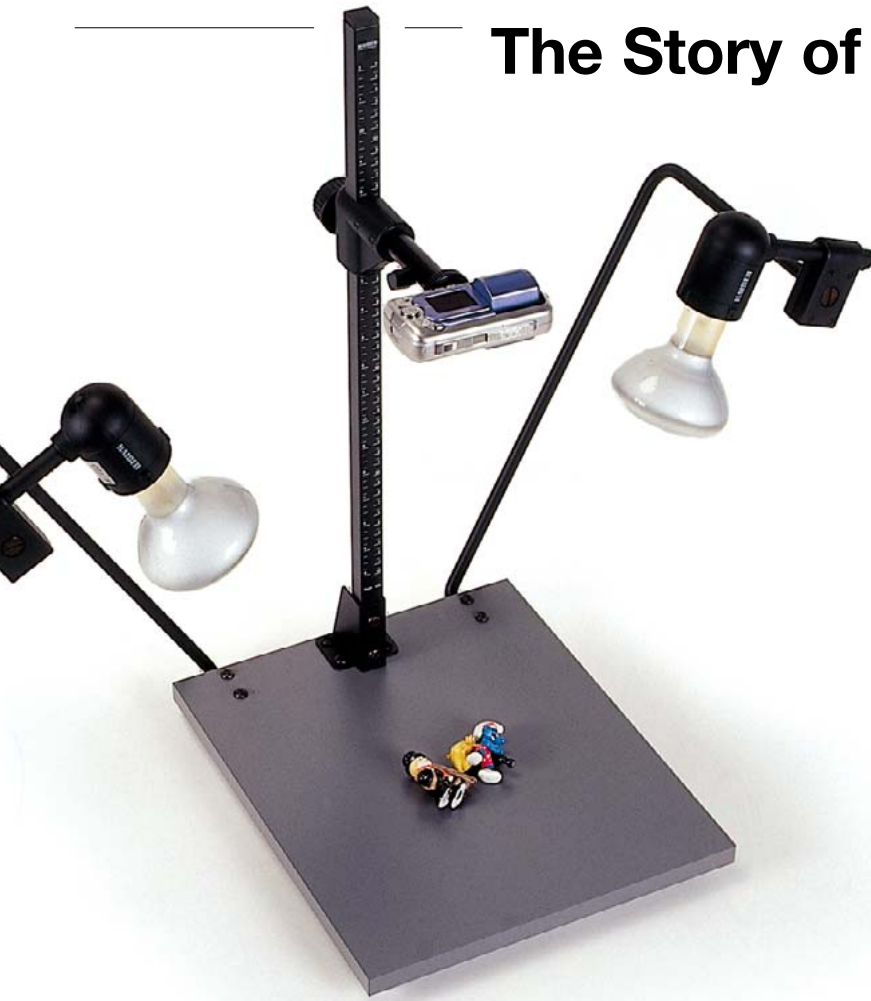

Is it really possible to make something that is innately rugged, sturdy and as vibration-resistant as possible still smaller, lighter and more „desktop-suitable“? Individuals with very small budgets and very small cameras have asked for that. And out of that request came the „reprokid“ - a small, light-weight, compact stand for small, light-weight, compact cameras.

This unit is „good enough“ for wherever the requirement is for minimum space and light weight. And really: even the price has moved accordingly.



5360 „reprokid“ Camera Stand

Super-compact camera stand for small, lightweight cameras (APS, digital compacts, CCD cameras, etc.). Non-reflective, matt-black baseboard. Column with cm/inch scale. Height-adjustable camera arm. 1/4" mounting thread.

Baseboard (WxHxD): 32 x 1.9 x 38 cm
(12.6 x 0.7 x 15 in.)

Column height: 59 cm (23.2 in.)

Max. load: 1 kg (2.2 lbs.)

Includes lighting unit with two E 27 screw-in mounts for lamps up to 250 Watt (supplied without lamps).

Power cable: 2 x 2.5 m (8 ft. 2 in.)

Suitable lamps:

3128: Reflector lamp 150 W, 3200 K

3127: Reflector lamp 250 W, 3400 K

5361 „reprokid“ Camera Stand

Same as 5360, but without lighting unit.

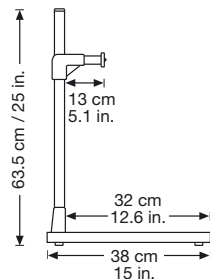

Hold the Post!

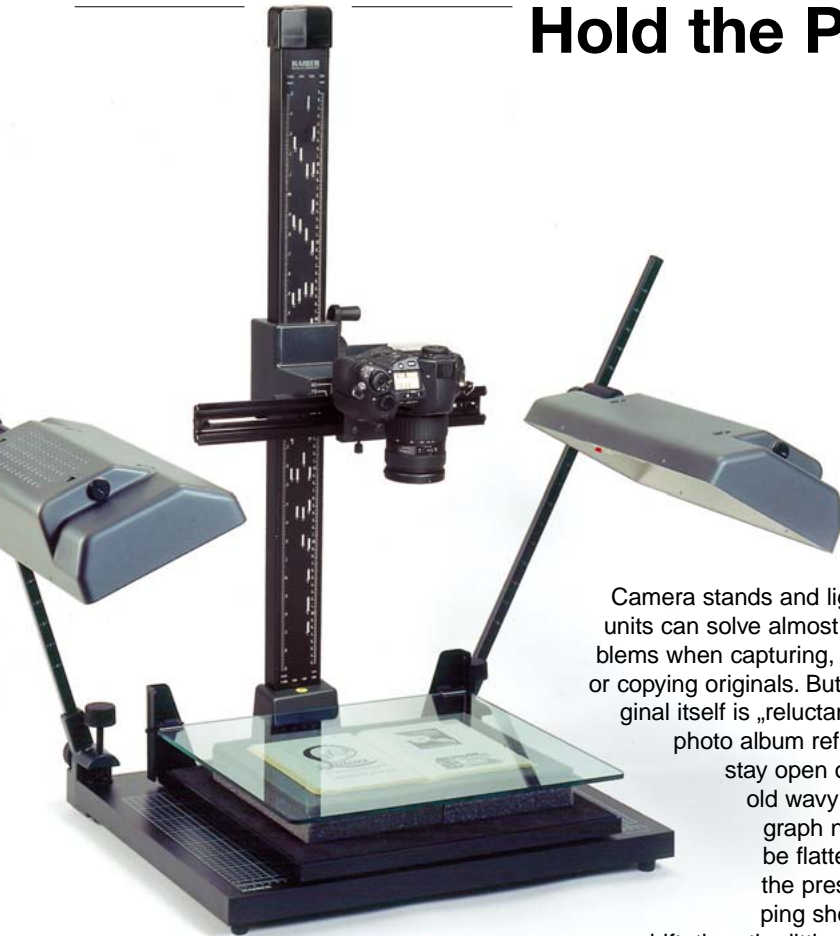

Camera stands and lighting units can solve almost all problems when capturing, digitizing or copying originals. But if the original itself is „reluctant“, if the photo album refuses to stay open or if the old wavy photograph needs to be flattened or the press clipping should not shift, then the little (or bigger) helpers presented here, are of great importance.

The 5901 Copy Plate is a reliable tool for locating originals in a certain position. The 5903 Document Holder does a similar job for smaller originals and allows the possibility to position the original at any desired angle towards the camera.

Especially when copying opened books or albums you have to fight the stubbornness of the inanimate. Normally an open book will not lie flat and each page bends differently. In these cases a book cradle is very helpful, but often expensive.

The Book Holder is a simple but efficient solution to this problem:

A solid baseplate is covered with a non-slip coating. Preformed foam elements of varying thickness are arranged in such a manner that the opened book is compensated, yet a gap is left down the middle for the book spine. A folding glass plate with hinges located in vertical slots exerts the necessary pressure to keep the page that is to be copied in a flat position. Moreover, part of the pressure is absorbed by the foam elements under the book so that even fragile books are treated with the utmost care.

The RLR Camera Arm (see page 91) should be used for page-by-page copying because the camera can always be positioned precisely over the corresponding page without having to move the book for each shot.

5904 Book Holder

43 x 41 cm (16.9 x 16.1 in.) sized, solid baseplate with non-slip coating on top non-slip feet underneath. 6 mm (0.2 in.) thick glass plate, foldable and variable in height up to maximum 95 mm (3.7 in.).

Incl. 8 preformed foam elements for height compensation: 2x 20 mm (0.8 in.), 2x 10 mm (0.4 in.) and 4x 5 mm (0.2 in.), and two black cardboard sheets (each one A4/letter size) so that the print on the back side cannot shine through the paper.

Dimensions (WxHxD): 465 x 130 x 450 mm (18.3 x 5.1 x 17.7 in.)

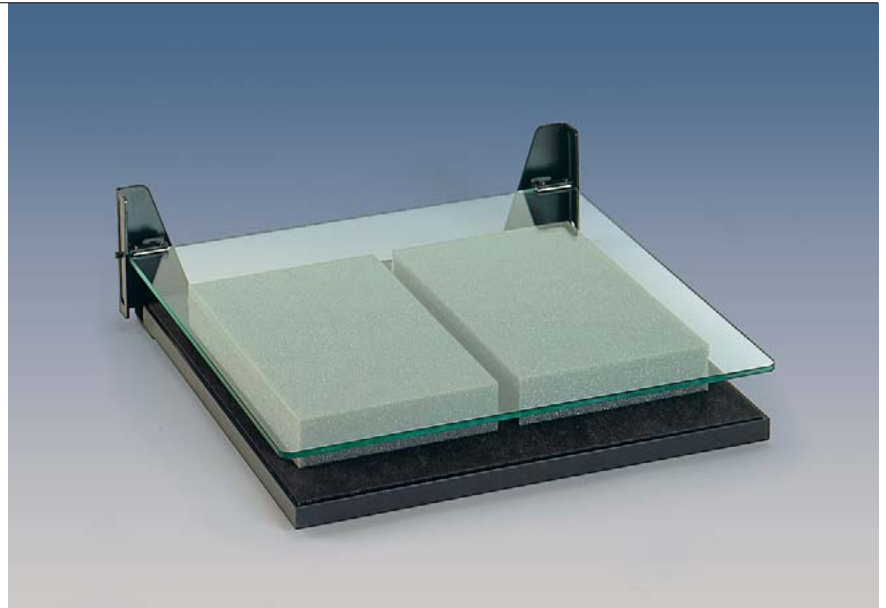

5539 RLR Camera Arm

For Copylizer and R1 system camera stands. For page-by-page copying from opened books or albums without moving the original. Camera platform can be shifted to left or right and locked in any position. Adjustable end-stops. Camera can be mounted in landscape or portrait position.

Moving distance of camera platform: 15 cm (5.9 in.) from center to right or left.

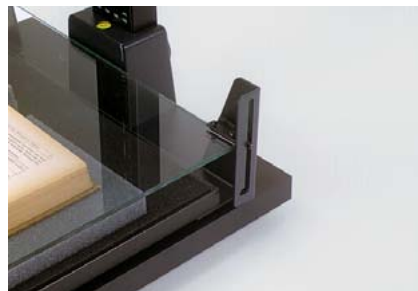

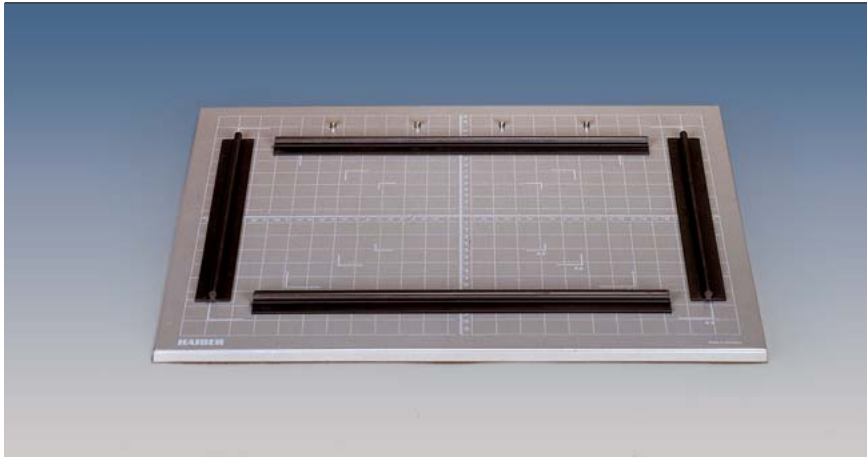

5901 Copy Plate

Metal base plate with non-slip bottom surface. Top surface is matt grey lacquer with 18 % reflection for determining exposure times. Printed grid lines with scales and DIN format markings. 4 copy subject holders made of permanently magnetised section plastic. 4 sinkable grid pins at standard hole intervals. Wall mounting is possible.

Size of printed grid area: 460 x 340 mm
(18.1 x 13.4 in.)

Dimensions (WxHxD): 500 x 10 x 380mm
(19.7 x .4 x 15 in.)



5903 Document Stage

Suitable for documents and originals up to 210 x 148 mm (8.2 x 5.8 in.).

Two adjustable stop rails for accurate positioning of the document. Fixing clamps can be used in various positions.

Platform on ball head can be swivelled and tilted in all directions and pivots to 90°. Height adjustment (up to 40 mm/1.5 in.) with blocking screw. Spirit levels in platform and base. Four individually adjustable feet.

Dimensions (WxHxD): 265 x 173 (213) x 210 mm
(10.4 x 6.8 (8.4) x 8.3 in.)

5907-08
Reflection Shield

Avoids reflection of the camera body on reflective originals. Attaches with holding ring in camera filter mount.

5907: For lenses with 62, 58 and 55 mm filter thread

5908: For lenses with 55, 52 and 49 mm filter thread



6385
Spirit Level

One level each for vertical and horizontal shooting position. With mounting shoe and 1/4" tripod bush.

Dimensions: approx. 20 x 25 x 35 mm
(.8 x 1 x 1.4 in.)



6386
Spirit Level

Circular bubble in metal mounting, self-adhesive. For permanent attachment to cameras, tripods etc. Can also be screwed on.

Diameter: approx. 25 mm (1 in.)



6388
Adhesive Paste

Permanently elastic putty for holding, supporting and arranging photo objects. The putty can be formed at will and sticks to the object. It can be removed without leaving any residue.

Package with 250 g (8.8 oz.)



Got it Straight?



If the film or chip plane and the original plane are not in an exactly parallel position, then we will get perspective distortions.

In any case you can check it using spirit levels, but the Enk adjusting device will really get it straight. Primarily designed to align the camera when doing shots of monitors, it finds another useful application here. An LED is positioned exactly in the center in front of an SLR camera lens and a mirror on the original plane. One look through the viewfinder shows it all: If the LED and its mirror image are not exactly matching, you have to adjust the camera or the object till you get them straight.

No, we do not talk about the photographer, but we are touching on an important issue when capturing images from a vertical position.



**5990
Adjusting Device**

For the exact alignment of the camera for screen shots and repro photography.

Adjusting device with centred light diode, cable with cable switch and detachable threaded ring with 58 mm screw-in thread. Adaptable to other filter threads with adapter rings. With compartment for 2 x 1.5 volt AA batteries and velcro strip for fastening the compartment to the tripod or camera stand.

Without batteries.

3-D: Definition, Duplication, Digitization

Even in the digital era a transparency on chemical reversal film undisputedly has a good reputation. Its definition, its resolution, its color rendition, in short - its quality is unquestioned.

Further the transparency is and remains a unique copy. If you need more than one piece, it has to be duplicated. If you need it in your computer, it needs digitization.

Duplication means, that the original transparency, transilluminated by color-calibrated and even light, has to be photographed once again on a suitable film, preferably a duplicating film. Slide duplicates can be produced conveniently using a camera stand and the color head of a color enlarger.

The color head, placed upside down in „reversed“ position, serves as the light source for the original. The shooting equipment - SLR camera, extension and a suitable lens - is attached to the camera arm.

The advantages of using the color head as a light source are firstly the constant color temperature of the halogen cold light mirror lamp used, which is standardized at 3200 Kelvin for the colour sensitizing of artificial light duplicating films, and secondly the trouble-free stepless correction filtration by means of the dichroic filters.

For the digitization of slides film scanners are a convenient and affordable solution, if we talk about 35 mm film. Film scanners for medium format or larger slides exceed the budget of the average user. Using a high-quality digital camera (with 3 megapixels or more) with a suitable lens (top-quality telephoto or macro lens with little distortion and shading and at suitable minimum shooting distance) in combination with the slide copying system is an interesting alternative, especially when it is possible to calibrate the camera with respect to the predefined color temperature of the light source. And moreover: you will always be faster this way than with a film or slide scanner.

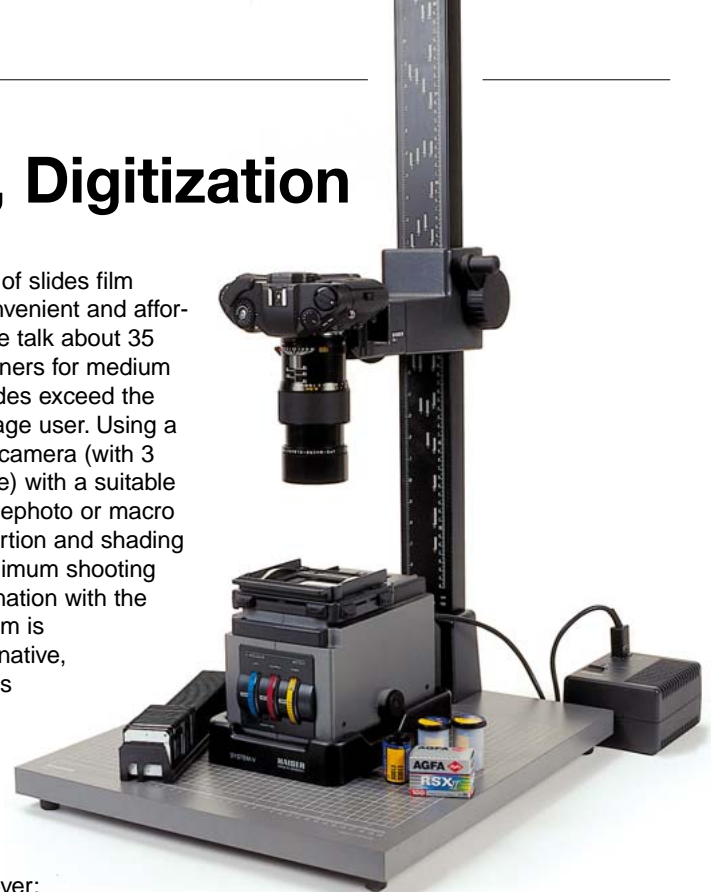



5972 Slide Copying System

For slides up to 6 x 6 cm (2.4 x 2.4 in.). Consisting of a color head with dichroic interference filters, white-light lever, density diaphragm, 12 V dichroic mirror halogen lamp, 100 W, 3200 K, diffuser for uniform illumination, cooling blower for continuous operation, compound negative carrier with four continuously variable masking strips, negative mask for 35 mm mounted slides, holder and hood for reversed color head, and one set of test slides.

Required: 4451 transformer (with electronic voltage stabiliser) or 4453 (without voltage stabiliser).



5975 Slide Copying System

Comprises color head with dichroic interference filters, white-light lever, density diaphragm, 12 V dichroic mirror halogen lamp, 100 W, 3200 K, diffuser for uniform illumination, as well as transformer, compound negative carrier with four continuously variable masking strips, negative mask for 35 mm mounted slides, holder and hood for reversed color head, and one set of test slides.

5969 Test Slides

For determining picture frame for copying 1:1. For determining correct exposure times for cropping and as an aid to establishing exposure, filtration and focus.

The set consists of 3 framed 35 mm slides.

5979
Slide Copying Kit

Consists of holder and cover for the up-turned color head. Allows the use of any colour head as light source for slide copying.



5973
Cooling Blower Module

For the 5975 Slide Copying System (produced as from 5/97). The blower can be attached to any lighting head using a 100 W halogen lamp. Separate power supply via the included mains adapter.



4544
Color Head



4459

Dichroic interference filters, calibrated in densitometric units up to 180, dials indirectly illuminated. White-light lever with control light. Continuously adjustable, illuminated density aperture up to 60 densitometric densities (= two aperture settings). Best possible light distribution due to special diffusor screen. UV filter and IR filter. Drawer for additional filters 85 x 85 mm (3.3 x 3.3 in.). Operation only with transformer 4451 or 4453. Supplied with halogen cold-light mirror lamp 12 V, 100 W.



4451/53
Transformer

4451: Transformer with starting-current limitation and electronic voltage stabilization.

4453: Without voltage stabilization.

5974
Conversion Filter

To be exchanged with the filter drawer of the color head. Required if slide copying is done with daylight film.

Dimensions: approx. 8.5 x 8.5 cm (3.3 x 3.3 in.)





5976
4 x 5" Slide Copying Adapter

To duplicate slides up to 4 x 5" in conjunction with the 5972/5975 Slide Copying Systems or with the 4544 Color Mixing Head. The adapter is mounted on the turned over color mixing head. Supplied with adapter plate so that a negative carrier can be positioned on the slide copying adapter.



4584
Compound Negative Carrier for 7 x 7 cm Slides

For mounted 6 x 6 slides with outer dimensions 7 x 7 cm (2.8 x 2.8 in.). Four steplessly adjustable masking strips for selecting the desired detail.



4583
Compound Negative Carrier

For use with all negative masks and glass inserts sized 100 x 72.5 mm (3.9 x 2.9 in.). Adjustable guide pins for various film widths. Four steplessly adjustable masking strips. Two register pins.



4489
Negative Mask for 5 x 5 cm Slides

For mounted slides with outer dimensions 5 x 5 cm (2 x 2 in.). For insertion into 4583 Compound Negative Carrier. Dimensions: 100 x 72.5 mm (3.9 x 2.9 in.)



4129
Film Loader

For loading bulk 35-mm film into cartridges in daylight. For bulk film material up to 30 m (98 ft.). With frame counter and remaining-film meter. Dimensions: approx. 130 x 110 x 80 mm (5.1 x 4.3 x 3.1 in.)



4124/27
Film Cartridges

For 35 mm film.
For self-loading with bulk film material.
Clamp fastener in reel axle.

4124: Metal type, 5 pcs.

4127: Plastic type, 5 pcs.