

BA210

Basic Biological
Microscope



Motic BA210

Basic Biological Microscope

is designed for both educational and teaching environments from basic life sciences to medical biological applications. The BA210's standard configuration best meets the needs of the High School, College-University, and Medical school markets. Through newly formulated Motic Infinity Optics (CCIS®), the BA210 delivers a new higher level of performance in education and training.

The New BA210 Series

With the BA210 Motic is setting a new standard in microscope performance through improvements both in optical and mechanical features for the student level. Designed to be used in Educational life science, Medical and a variety of biological applications, the BA210 is designed for ease of use and longevity due to Motic's complete understanding of the daily demands placed on the standard educational microscope.

Student proof features, working together with a new generation of EF-N Plan Achromatic objectives provide a fully corrected intermediate image for crisp and clear visual and digital results.

Whether using the new powerful 6V/30W Halogen stand or the 3W LED version, light consuming contrast methods like Phase contrast, Polarization or Darkfield are easily performed.

Motic BA210 is a robust student instrument that brings professional, repeatable image quality results to all of its intended applications.

New Motic EF-N Plan Achromats





BA210 Binocular



BA210 Trinocular

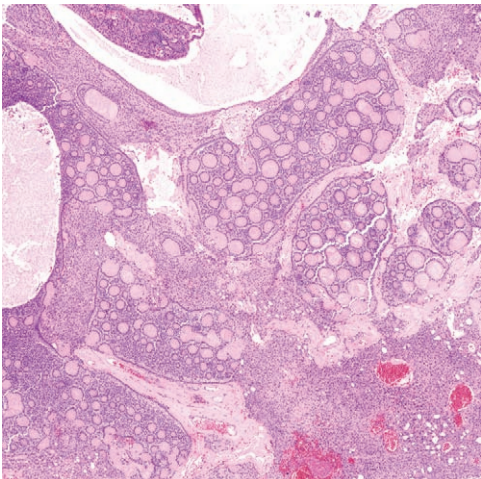
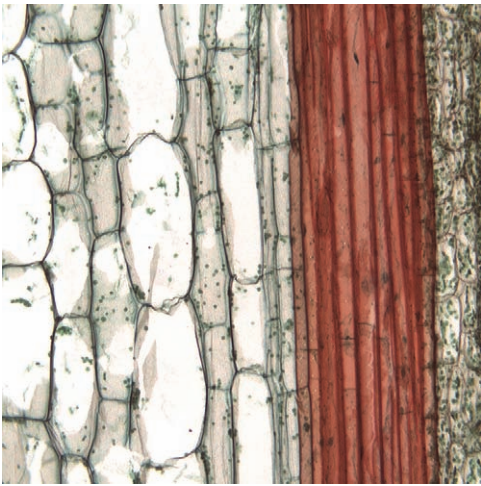
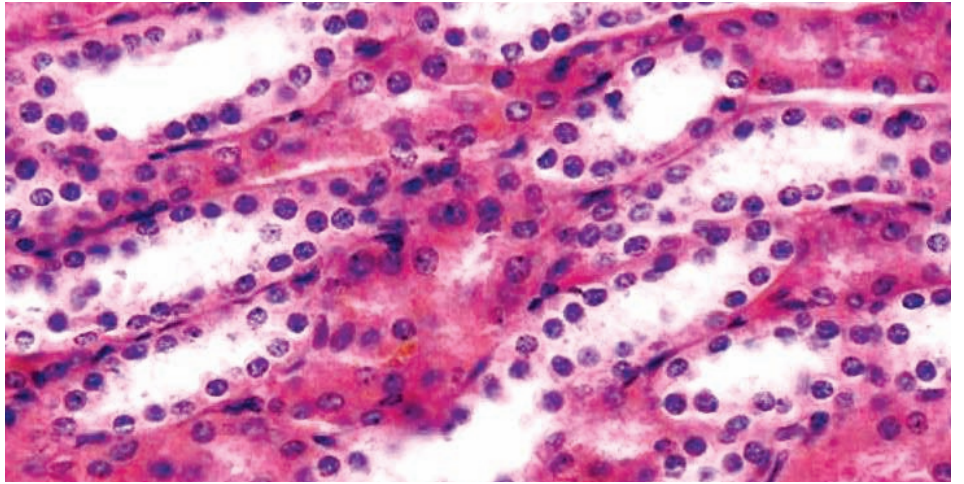
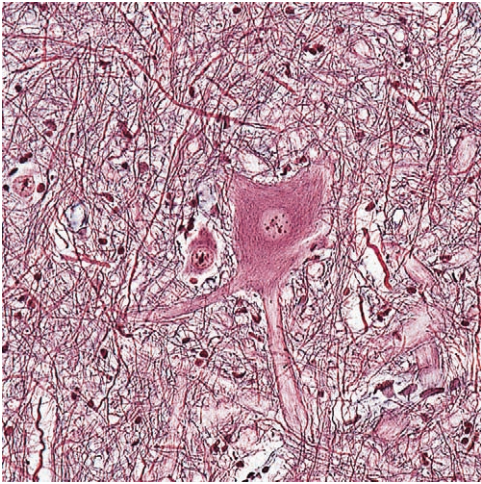

► CCIS® Objectives

To improve overall optical performance of the BA210, Motic introduces a newly designed generation of Plan Achromatic Objectives made of high quality optical glass: CCIS® EF-N Plan. These new lenses are now MULTI LAYER COATED for improved contrast to enhance images even with weak slide stainings.

Together with a newly calculated tube lens, the result is a FULLY CORRECTED, perfected intermediate image without colored fringes. The Trinocular BA210 gives digital access to the same for even sharper imaging and improved digital output quality for professional results at the student level.

Type	N.A.	W.D. (mm)
EF-N Plan 4X	0.1	6.3
EF-N Plan 10X	0.25	4.4
EF-N Plan 20X	0.4	4.66
EF-N Plan 40X, Spring	0.65	0.35
EF-N Plan 60X, Spring	0.85	0.13
EF-N Plan 100X, Spring, Oil	1.25	0.13
EF-N Plan Phase 10X	0.25	4.4
EF-N Plan Phase 40X, Spring	0.65	0.35

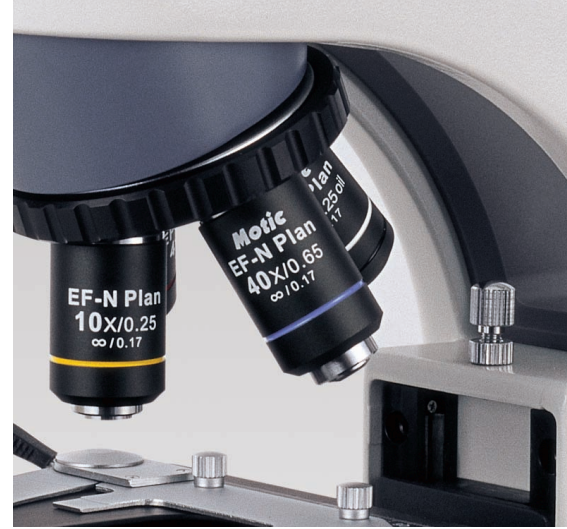

► Eyepieces

The new standard eyepieces, also made of high quality optical glass, N-WF 10x/18 FOV or N-WF 10x/20 FOV with high-eyepoint for eyeglass wearers provides consistent diopter adjustments for both eyes. This enables perfect usage of reticles for measuring, counting, etc. Standard lockable eyepieces ensure against inadmissible removal and confirms Motic's dedication to student proof quality.

The following reticles are available:

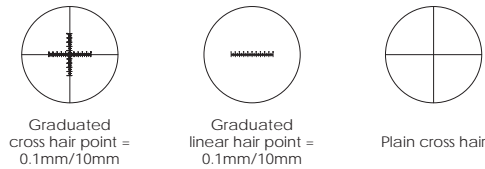

Description	F.N.
Widefield high eye point N-WF 10X	20
Widefield high eye point N-WF 12.5X	16
Widefield high eye point N-WF 15X	13.3



► Observation Tubes

Designed with an ergonomic viewing angle of 30° and incorporating an interpupillary distance of 55-75mm, the BA210 observation tubes guarantee fatigue-free viewing for hours.

A large field of view option (20mm) enables fast and comfortable screening.

The trinocular tubes allow digital documentation and integration of each BA210 into a wide variety of digital cameras, with optional 20/80 or 0/100 light splits for the trinocular exit.



► Illumination

The BA210 introduces a new collector lens assembly with a secure, screw-on holder for the frequently used Blue daylight filter, which is an integral part of the illumination package. The fixed cap prevents the filter from dropping when the instrument is stored.

6V/30W Halogen, 3W LED or mirror -
The BA210 offers multiple illumination options to use on the microscope.



► Condenser

To ensure the perfect height adjustment of the condenser, a condenser lock is available. While using phase/darkfield sliders, the teacher can pre-set the condenser position to prevent potential student mis-adjustments.

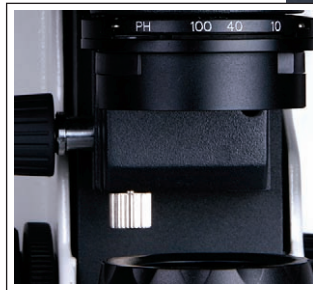

► Mechanical Stage

The BA210 surprisingly offers an optional left/right hand control and the new slide holder enables consistent sample movement across a 76x30mm range. The model also offers a hard coated surface, resistant against routine usage abrasion and most lab chemicals.



Stage for Left-Hand



Stage for Right-Hand



► Simple Phase Contrast and Darkfield

Offered as an option, phase contrast is available for magnifications 10X and 40X. Darkfield is possible with a separate DF slider.

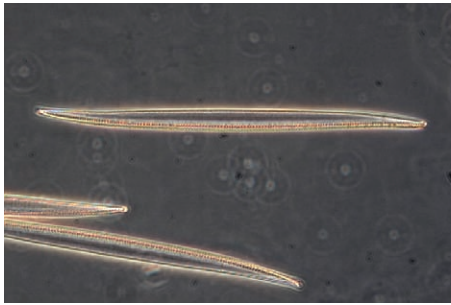

► Simple Polarisation

Convenient and simple, the BA210 polarisation system consists of an analyser filter placed between the head and body; and a polariser filter placed on top of the collector lens.

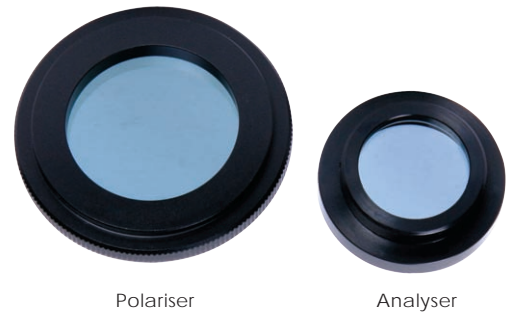
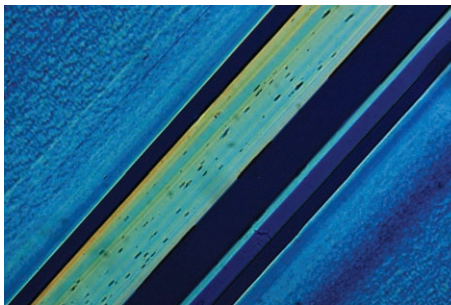

► Anti-Fungus Design

To protect the system from fungus formation in high-humidity environments, an anti-fungus device is used to prolong the life of both microscope and objectives.

► BA210 Digital Schematic Diagrams

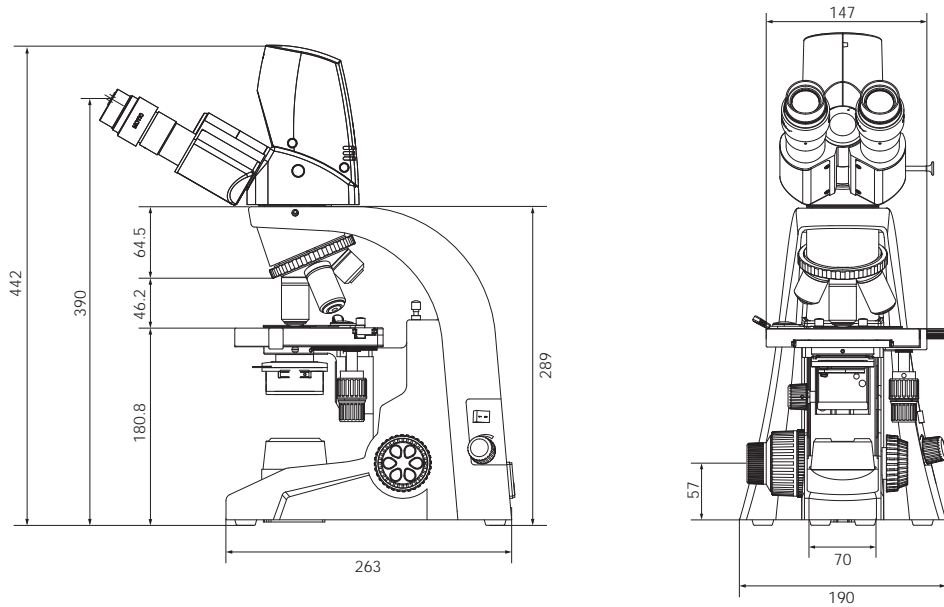

Unit: mm

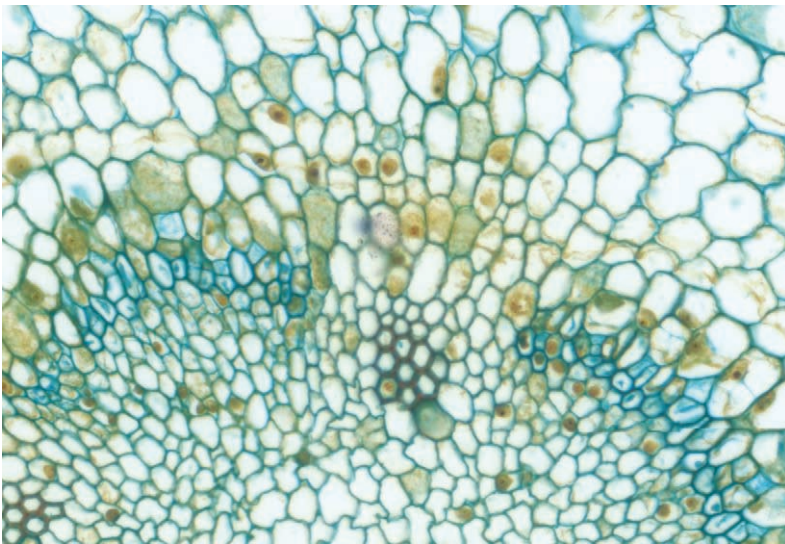

■ BA210 Digital

Documentation

The importance of documentation has expanded into every aspect of microscopy, as has the method of documentation. The BA210 is available with both a traditional method (photomicrography) and a digital method.

► Standard Photomicrography

Selecting the trinocular version of the BA210 allows the user to capture the images observed through a photomicrography system.

The system consists of a mechanical adaptation combined with a photo eyepiece (2.5X or 4X)

The T2 adapter referring to the camera model is supplied by the camera manufacturer.



*Final adapter must be provided by camera manufacturer

► Digital Documentation

Digitalisation of microscopy is Motic's philosophy and the BA210 provides two methods of digitalisation.

The integration of the BA210 trinocular microscope and Moticam series of digital cameras delivers crisp and live images. All Moticams come equipped with software to transfer the BA210 into an analysis and documentation station. Please consult the Motic Digital Series of brochures for further details.

Should you select a third-party camera, Motic provides a range of CCD-adapters covering all demands for field vs. resolution.

Another digitalisation option is the BA210 digital head. Conventional replacement of the existing head with BA210 Digital transforms the BA210 into a teaching, training, and analysis station without the hassle of adapters and focus corrections. With a USB2.0 output to the computer, the system provides high resolution imaging in both real time and capture modes. For further information, please refer to the BA210 Digital brochures.



■ BA210 with Moticam 2300

► BA210 Standard Specifications

Model	BA210
Optical System	Color Corrected Infinity Optical System [CCIS®]
Observation Tube	Widefield binocular 30° [F.N. 20] Widefield trinocular 30° [F.N. 20]- light distribution 20/80 Widefield trinocular 30° [F.N. 20]- light distribution 0/100
Nosepiece	Reversed quadruple
Stage	140 x 135mm surface; 76 x 30mm movement; coaxial movement
Condenser	N.A. 1.25 Abbe condenser with slider slot; Focusable and Lockable
Focus	Brass gears 25mm stroke; 2µm minimum increments; torque adjustment for coarse
Illumination	Built-in transmitted 6V/30W halogen critical illumination Built-in transmitted 3W LED illumination of 5,500K Colour Temperature; >10,000 hrs bulb life span Attachable Mirror set

► BA210 Digital Standard Specifications

Model	BA210 Digital	
Optical System	Color Corrected Infinity Optical System [CCIS®]	
Observation Tube	Widefield binocular 30° [F.N. 20] with built-in 3 megapixel digital camera- light distribution 20/80	
Camera Specifications	Effective Pixels	3 megapixels
	Live Image Resolution	2048 x 1536
	Data Transfer	480 MB/Second USB 2.0
	White Balance	Manual adjusted using software
	Recommended System Requirements	Windows: XP or Vista; P4 1.0GHz 256MB RAM, USB 2.0 Mac: OSX, 1.0GHz 256MB RAM, USB 2.0

► BA210 Schematic Diagrams

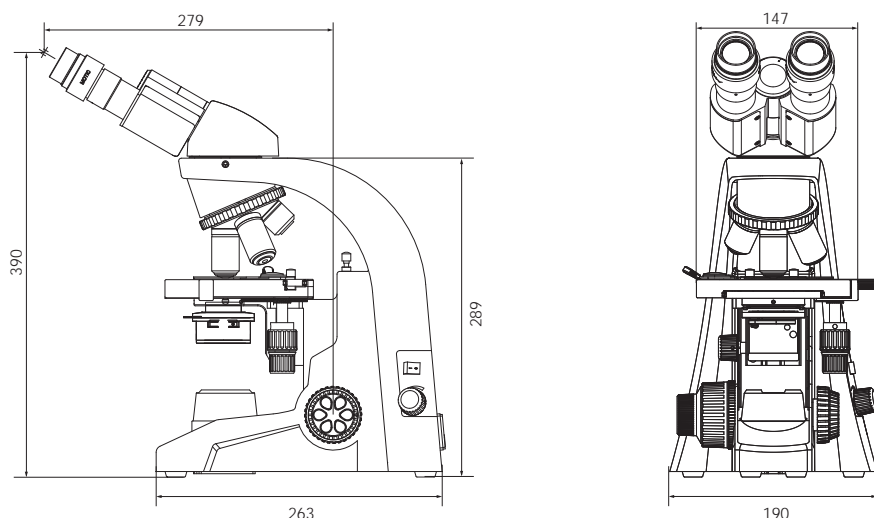

Unit: mm

▶ BA210 System Diagram

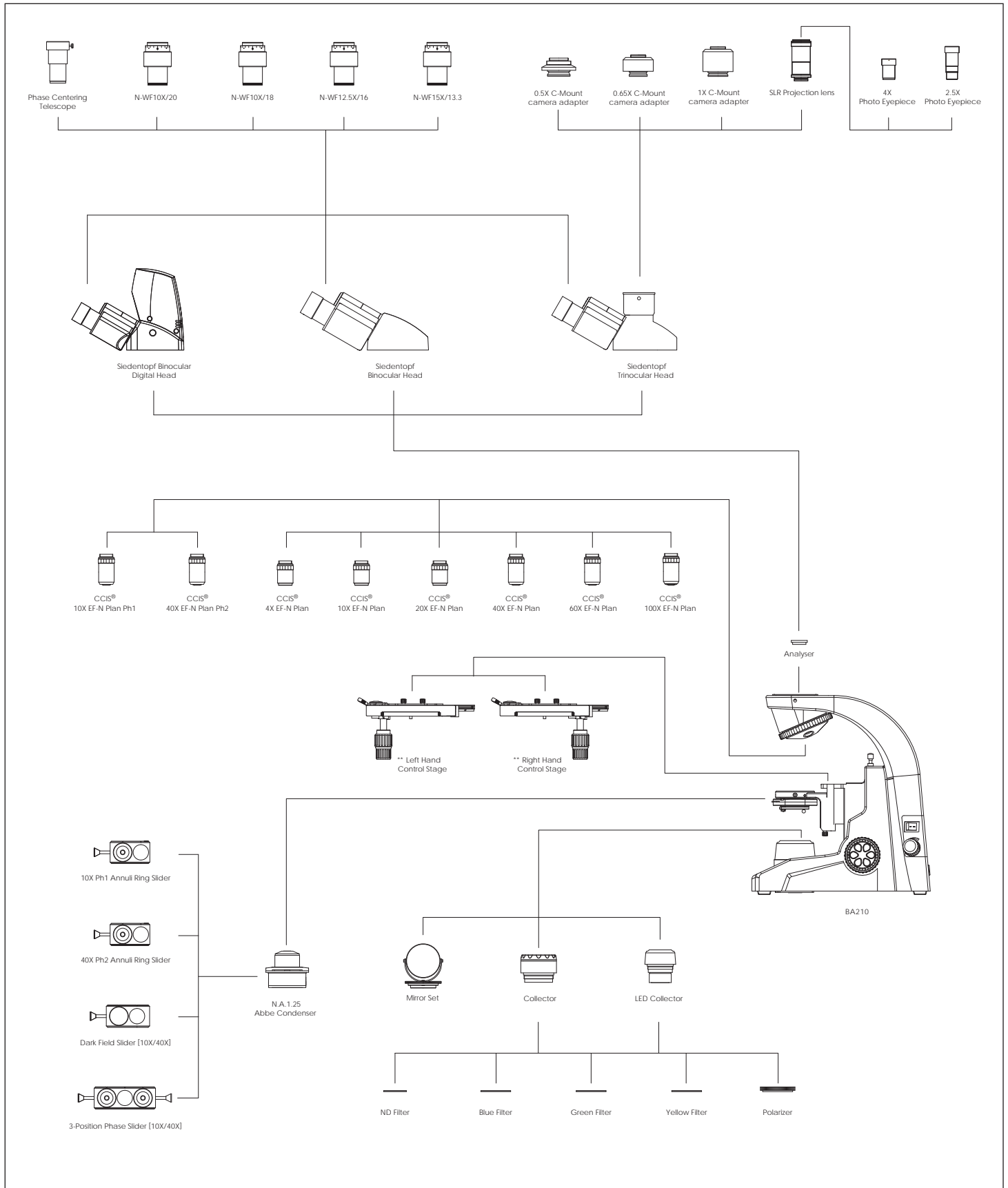

** Stages: To be ordered with stand

www.motic.com

Motic®

* CCIS® is a trademark of Motic Incorporation Ltd.

More Than Microscopy

Motic Incorporation Ltd. (HONG KONG)

Rm 2907-8, Windsor House, 311 Gloucester Road, Causeway Bay, Hong Kong
Tel: 852-2837 0888 Fax: 852-2882 2792

Motic Instruments Inc. (CANADA)

180-4320 Viking Way Richmond, B.C. V6V 2L4 Canada
Tel: 1-877-977 4717 Fax: 1-604-303 9043

Motic Deutschland GmbH (GERMANY)

Christian-Kremp-Strasse 11, D-35578 Wetzlar, Germany
Tel: 49-6441-210 010 Fax: 49-6441-210 0122

Motic Spain, S.L. (SPAIN)

Polígono Industrial Les Corts, Camí del Mig, 112 08349 Cabrera de Mar, Barcelona Spain
Tel: 34-93-756 6286 Fax: 34-93-756 6287

For inquiries in UK (UK)

Saracens House, 25 St. Margarets Green, Ipswich, IP4 2BN, Suffolk, UK
Tel: 44-(0)-14732 81909 Fax: 44-(0)-14732 11508

Motic Incorporation Limited Copyright © 2002-2008. All Rights Reserved.

Design Change : The manufacturer reserves the right to make changes in instrument design in accordance with scientific and mechanical progress, without notice and without obligation.



SAP Code: 1300901302862
Updated: Aug 2008